



**Feron**

КАТАЛОГ

# Содержание

Лампы .....	2
Галогенные .....	2
Светодиодные .....	3
Металлогалогенные .....	4
Энергосберегающие .....	5
Люминесцентные .....	7
Светильники .....	8
Пылевлагозащищенные .....	8
Направленного света .....	9
Люминесцентные .....	10
Точечные .....	14
Мебельные .....	15
Декоративные .....	17
Для подсветки .....	22
Встраиваемые .....	24
Со светодиодами .....	28
Настольные .....	30
Прожекторы и фонари .....	31
Прожекторы .....	31
Металлогалогенные прожекторы .....	32
Фонари .....	33
Головные фонари .....	33
Садово-парковые светильники .....	34
Тротуарные .....	34
Газонные .....	35
"Каменные" .....	36
"Пушкинские" .....	36
"Техно" .....	40
Датчики .....	42
Розетки-таймеры .....	43
Трансформаторы .....	44
Балласты, патроны .....	45
Удлинитель, детекторы .....	45
Дюралайт, ночники .....	46
Звонки .....	47

MR11 / 220V

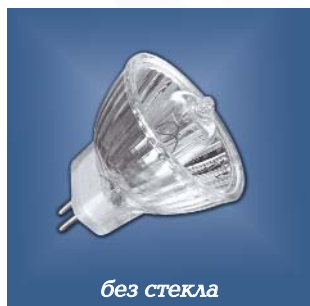

MR11 / 12 V

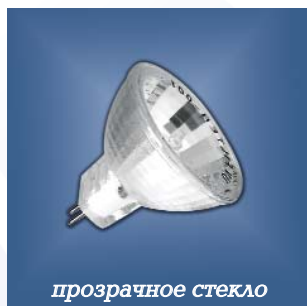

MR16

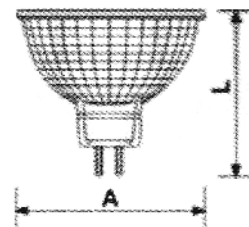
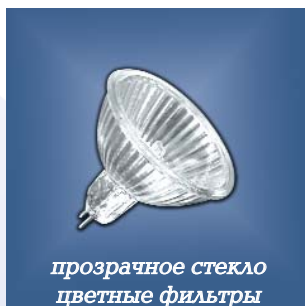

MRG

JDR

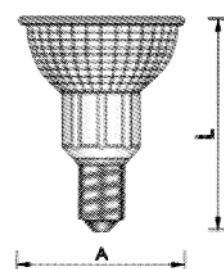
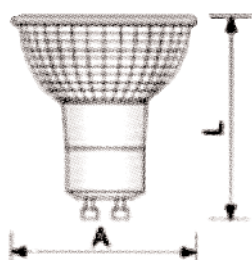
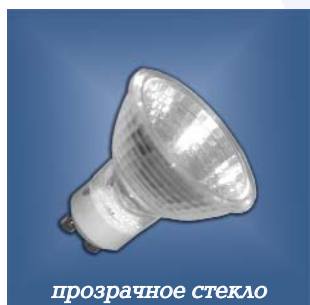

JCDR

JC

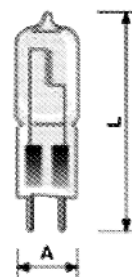
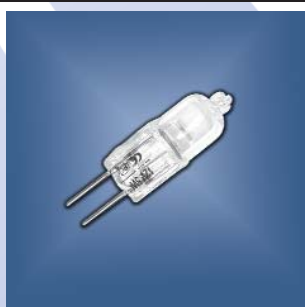
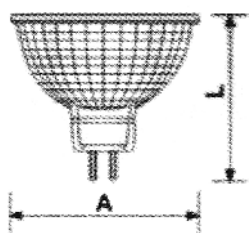
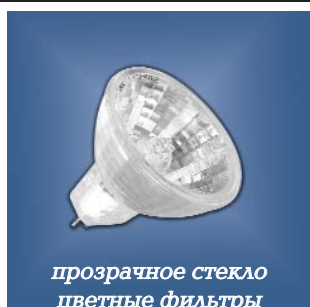

JCD

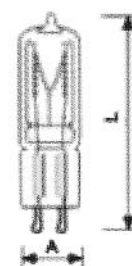
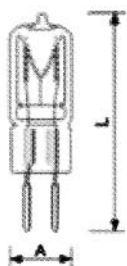
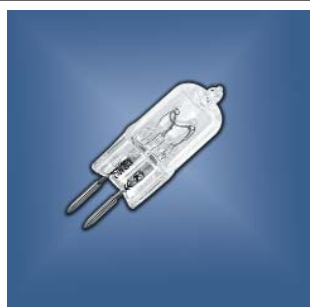

Наименование	Цоколь	Мощность, W	Напряжение, V	L, мм	A, мм
MR11	G5.3	20/35	220	40	35
MR11	G4	20/35	12	40	35
MR16	G5.3	20/35/50/75	12	45	50
MRG	GU10	35/50/75	220	52	50
JDR	E14	35/50/75	220	73	50
JCDR	G5.3	20/35/50/75	220	45	50
JC	G4	5/10/20	12	33	9
JC	G5.3	35/50/70	12	44	12
JC	G6.35	100	12	44	12
JCD	G5.3	20/35 /50	220	45	13
JCD	G5.3	75	220	54	13
JCD	G6.35	100/200	220	54/62	13
JCD9	G9, керамика	20/35/50/75	220	53	18



# Лампы

## галогенные

<i>J78</i>	<i>J118</i>	<i>J189</i>	<i>J254</i>
			
прозрачное стекло	прозрачное стекло	прозрачное стекло	прозрачное стекло
<i>J78/J118/J189/J254</i>		<i>PAR 38</i>	<i>PAR 36</i>
			
	прозрачное стекло		прозрачное стекло

Наименование	Цоколь	Мощность, W	Напряжение, V	L, мм	A, мм
J78	R7s	60/100/150/200/250	220	78	Q 8
J118	R7s	100/150/200/250/300/500	220	118	Q 8
J189	R7s	1000	220	189	Q 10
J254	R7s	1000/1500	220	254	Q 10
PAR38	E27	100	220	136	123
PAR36	E53	75	12	55	Q 112

## светодиодные

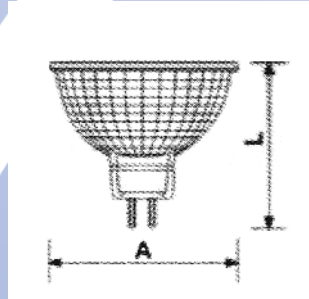
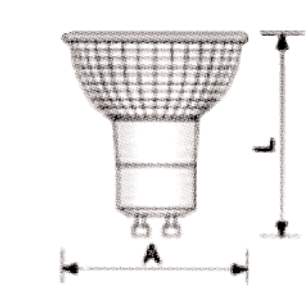
<i>JCDR-LED18</i>	<i>GU10-LED18</i>
	
18 светодиодов	18 светодиодов
	

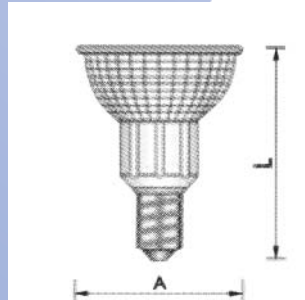
<i>JDR-LED18</i>

18 светодиодов

Наименование	Цоколь	Напряжение V	L мм	A мм
JCDR-LED18	G5.3	220	45	50
GU10-LED18	GU10	220	52	50
JDR-LED18	E14/E27	220	73	50

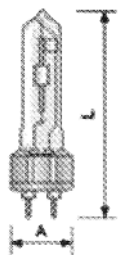
**MHB G12/HID1**

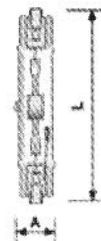

**MHB/D-END/HID2**



**MHB/ED/HID3**

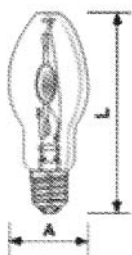

**MHB/T/HID4**

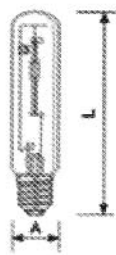

**MHB/BLENDED**



Наименование	Цоколь	Мощность, W	Напряжение, V	L, мм	A, мм
MHB G12/HID1	G12	70	220	100	20
MHB/D-END/HID2	R7s	70	220	118	25
MHB/D-END/HID2	R7s	150	220	135	25
MHB/ED/HID3	E40/E27	150/250	220	150/226	50/91
MHB/ED/HID3	E40	400	220	280	122
MHB/T/HID4	E40	250	220	211	47
MHB/T/HID4	E40	400	220	275	48
MHB/BLENDED	E27	125/160	220	170	70
MHB/BLENDED	E40	250	220	215	90
MHB/BLENDED	E40	500	220	285	115

ESB68

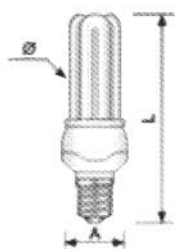

ESB71

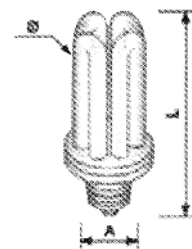

ESB143

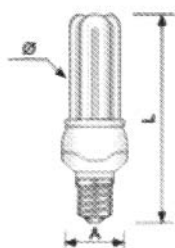

ESB7

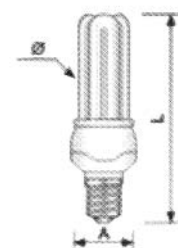

ESB16

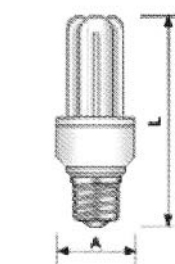

ESB25/26

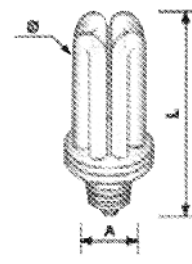

ESB14

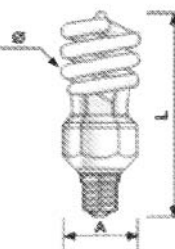

ESB182

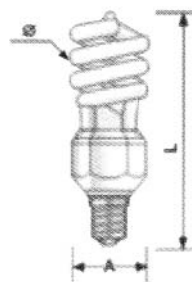

Наименование	Цоколь	Мощность, W	Напряжение, V	L, мм	A, мм	Q, мм
ESB 68	E14	MINI 2U 9/11	220	140	40	10
ESB 71	E27	MINI 4U 15/20	220	124/134	50	9
ESB 143	E27	4U 65/85	220	275/325	75	11
ESB 7	E27	3U 15/18	220	150	45	13
ESB 7	E27	3U 20/22	220	156	45	13
ESB 7	E27	3U 24/26	220	165	45	12
ESB 16	E27	MINI 3U 20	220	134	42	9
ESB 25/26	E27	4U 30/32/34 45/55	220	160/170/180 218/242	60/60/60 65/65	11/12/12 15/15
ESB 14	E27	15/20/24	220	137/144/159	52	12
ESB 182	E14	9/11/15	220	110/115/125	40	10

**ESB29**

**ESB119**

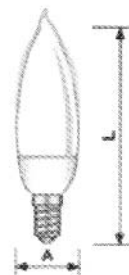
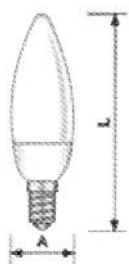

**ESB32**

**ESB45/43**

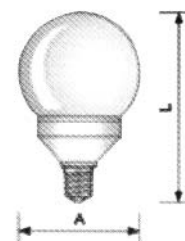
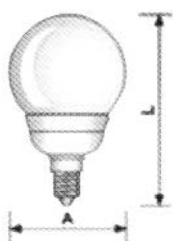

**16/1320/1310/EST12**

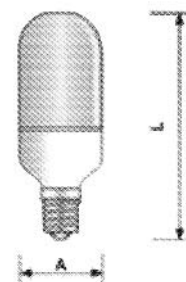
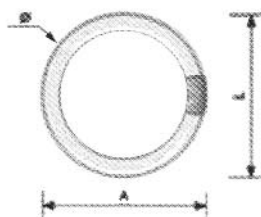
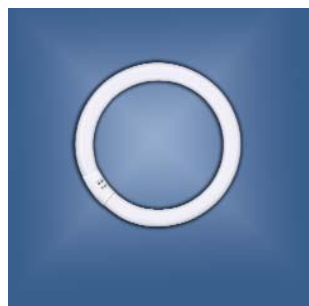

Наименование	Цоколь	Мощность, W	Напряжение, V	L, мм	A, мм
ESB 29	E14	9/11	220	120/130	40
ESB119	E14	7	220	130	40
ESB 32	E14	11	220	105	70
ESB 45	E27	15/20/25	220	160/170/185	90/100/120
EST 12	T5	28	220	244	248; Q 18
16/1320/1310	T9	22/32	220	216/305	203/292; Q 31
ESB 40	E27	15/20/25	220	160/175/185	70

**EST1**

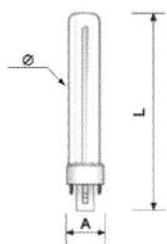

**EST3**

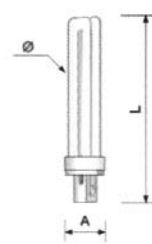

**EST13/T4**

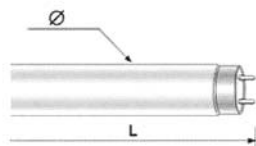
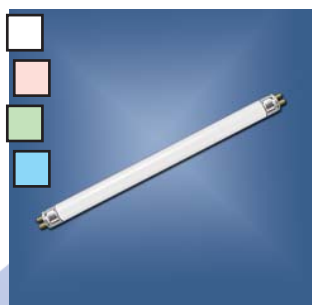

**EST14/T5**

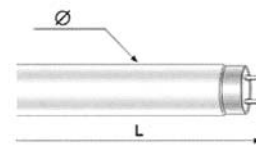
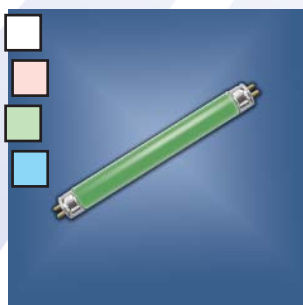

**FLU1/T8**

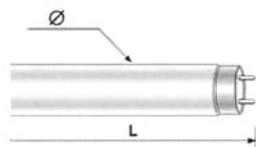
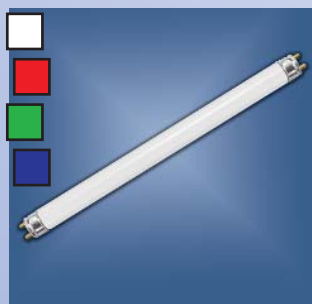

**FLU 10/T5/T8 ультрафиолетовая**

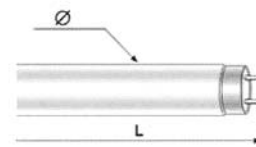
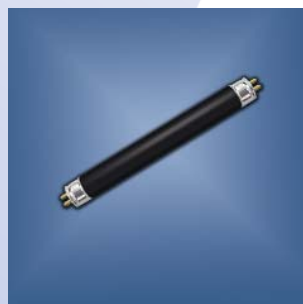

Наименование	Цоколь	Мощность, W	Напряжение, V	L, мм	A, мм	Q, мм
EST 1	G23	1U 5	220	107	28	12
EST 1	G23	1U 7	220	137	28	12
EST 1	G23	1U 9	220	167	28	12
EST 1	G23	1U 11	220	237	28	12
EST 3	G24	2U 13	220	151	28	12
EST 3	G24	2U 18	220	171	28	12
EST 3	G24	2U 18	220	191	28	12
EST 13/T4	G5	6/8	220	221/340		12
EST 13/T4	G5	12/16	220	370/470		12
EST 13/T4	G5	20/25	220	569/655		12
EST 13/T4	G5	30	220	770		12
EST 14/T5	G5	6/8	220	226/302		17
EST 14/T5	G5	13/21	220	531/863		17
EST 14/T5	G5	28	220	1163		17
FLU 1/T8	G13	10/15	220	345/451		26
FLU 1/T8	G13	18/30	220	604/909		26
FLU 1/T8	G13	36	220	1213		26
FLU 10/T5 ультраф.	G5	4/6/8/13	220	150/226/ 302/531		16
FLU 10/T8 ультраф.	G13	10/15/18 30/36	220	345/451/604 909/1213		26



1201/1401



1101/1301



1207/1407



1107/1307

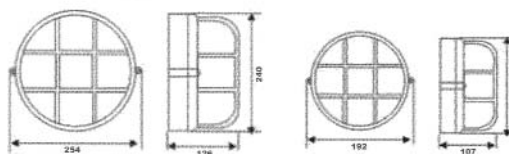
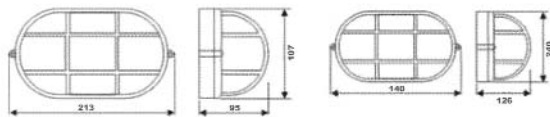

Наименование	Патрон	Мощность, W	Цвет исполнения	L, мм	A, мм	H, мм
1201	E27	100	белый, черный	240	140	126
1401	E27	60	белый, черный	213	107	95
1202	E27	100	белый, черный	240	140	131
1402	E27	60	белый, черный	213	107	100
1207	E27	100	белый, черный	240	140	131
1407	E27	60	белый, черный	213	107	100
1101	E27	100	белый, черный	240	254	126
1301	E27	60	белый, черный	177	192	107
1102	E27	100	белый, черный	240	254	131
1302	E27	60	белый, черный	177	192	112
1107	E27	100	белый, черный	240	254	131
1307	E27	60	белый, черный	177	192	112
1108	E27	100	белый, черный	240	254	131
1308	E27	60	белый, черный	177	192	112

AL 5101/5201

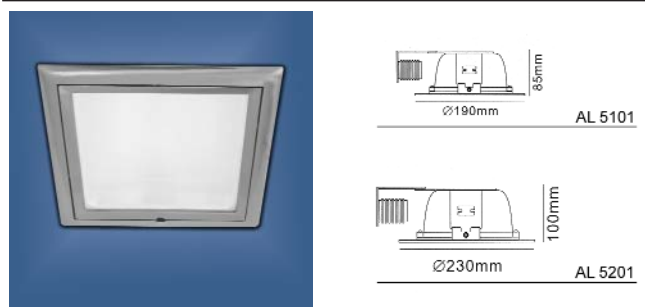

AL 5301/5401

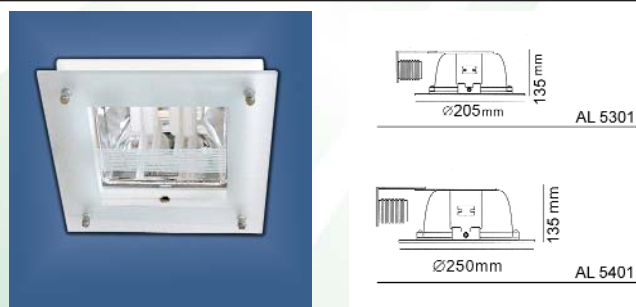

SP 025

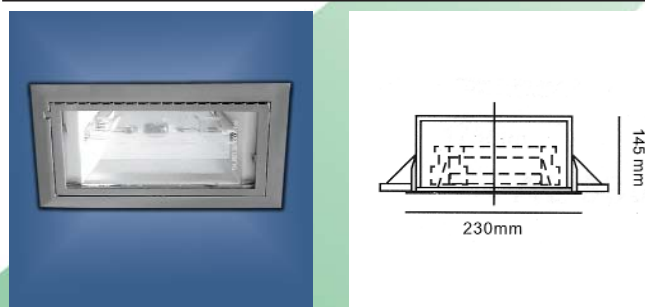

013/014/015

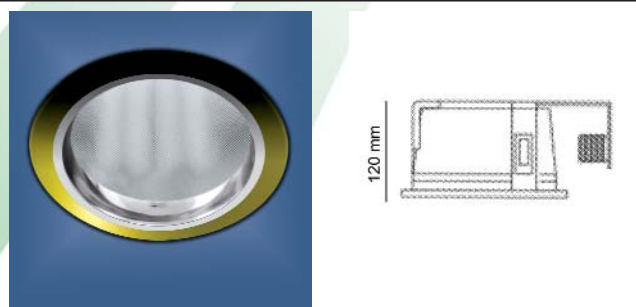

DL 33/35/37

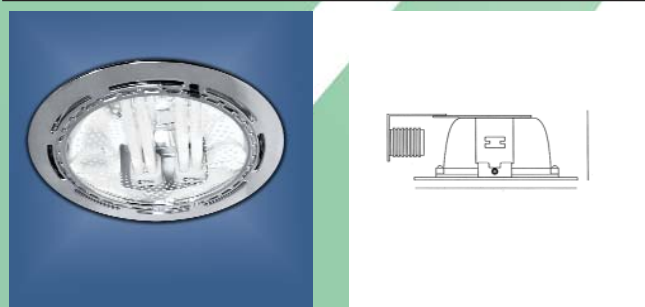

DL 39



Наименование	Цоколь	Мощность W	Напряжение V	Встраиваемый размер, мм	Геометрические размеры, мм	Цвет исполнения
AL 5101	G24	2*13	220	175x175	190x85	белый, титан
AL 5201	G24	2*26	220	215x215	230x100	белый, титан
AL 5301	G24	2*13	220	175x175	205x135	белый
AL 5401	G24	2*26	220	215x215	250x135	белый
SP 025	R7s	150	220	210x115	230x145x110	белый, хром, золото
013	G24	1*13	220	D 120	140x120	белый, хром, золото
014	G24	2*18	220	D 150	170x120	белый, хром, золото
015	G24	2*26	220	D 170	190x120	белый, хром, золото
DL 33	G24	2*13	220	D 142	162x122	белый, хром, золото
DL 35	G24	2*18	220	D 205	225x130	белый, хром, золото
DL 37	G24	2*26	220	D 210	230x102	белый, хром, золото
DL 39	E27	2*100	220	D 204	224x112	белый, хром, золото
SP 022 (стр.10)	G12	70	220	D 150	170x188	белый
SP 023 (стр.10)	R7s	150	220	D 204	230x95	белый
DM 4204-1 (стр.10)	E27	60	220	D 120	145x92	белый, хром
015 turbo (стр.10)	G24/E27	2*26	220	D 170	190x105	белый

SP 022

SP 023

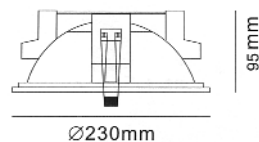
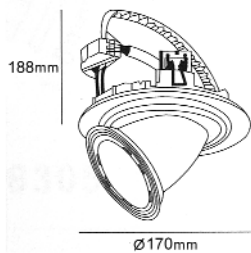

поворотный (170')  
с пускателем

лампа - J118

DM 4204-1

015 turbo

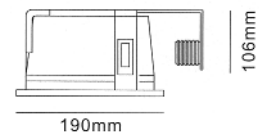
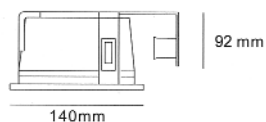

### ЛЮМИНЕСЦЕНТНЫЕ

TL 0001

TL 0002

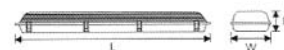
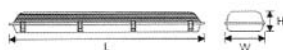

TL 0003

TL 0004



**TL 0006**

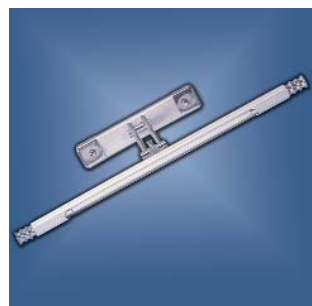

45mm  
32.5mm

**TL0007**



45mm  
32.5mm

**TL 0008**

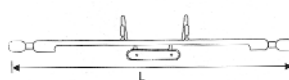
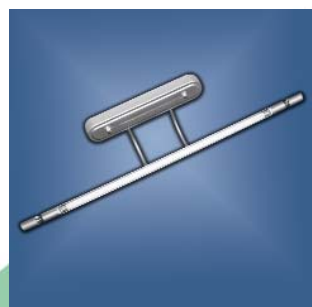

**TL 2201**

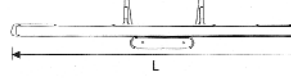

**CAB 1**



40mm  
17mm

**CAB 2**



40mm  
17mm

**CAB 27**

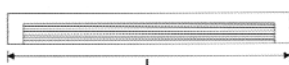

75mm  
54mm

**CAB 28**

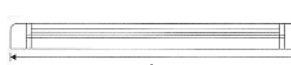

44mm  
22mm

**CAB 3/CAB 3N**



65mm  
35mm

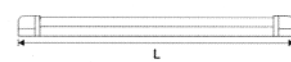

50mm  
30mm

**CAB 4/5**

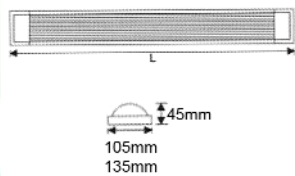

**TL 3013S/3017S**

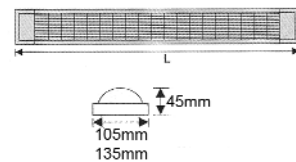
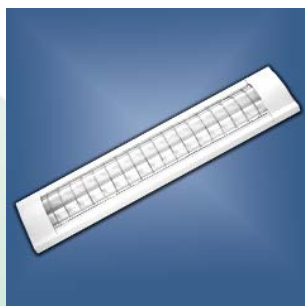

**CAB 35**

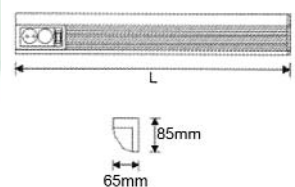

**CAB 1A / CAB 2A**

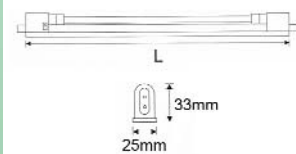

**CAB 89A**

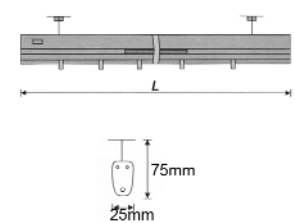

**CAB 89B**

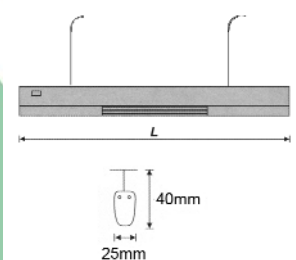

**CAB 90**

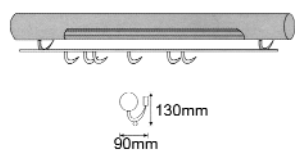

**CAB34**

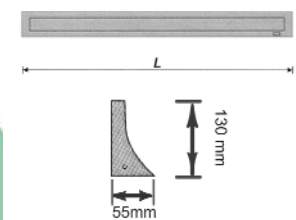

**TL 2016**

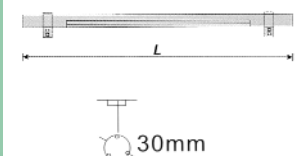
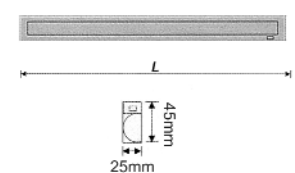

TL 2018C

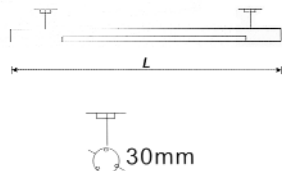

СAB 45/46



TL 2012

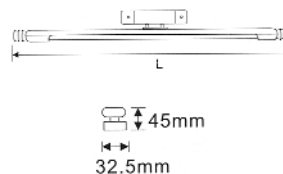

Наименование	Лампа	Мощность, W	Цвет исполнения	L, мм
TL 0001	T8	2*20 / 2*40	белый	675/1286 W 170 H 100
TL 0002	T8	2*20 / 2*40	белый	645/1242 W 200 H 70
TL 0003	T4	15/20	хром	615/740 x 50 x 120
TL 0004	T4	15/20	хром, золото, титан	615/735 x 40 x 100
TL 0006	T4	15/20	хром, золото, титан	610/730x65x175
TL 0007	T4	15/20	хром, золото, титан	610/730x65x175
TL 0008	T4	15	хром, золото, титан	635x125x165
TL 2201	T4	8/15/20	хром, золото, титан	370/550/670x200x170
СAB 1	T4	6/8/12 16/20 25/30	белый	260/380/410 510/605 690/800
СAB 2	T4	6/8/12 16/20 25/30	белый	260/380/410 510/605 690/800
СAB 27	T8	15/18/30/36	белый	505/655/960/1265
СAB 28	T5	6/8/12 21/28	белый, дерево	270/345/570 910/1210
СAB 3/3N	T8	10/15/18 30/36/58	белый	415/520/675 975/1280/1580
СAB 31	T8, T8 BLB	10/15/18 30/36/58	белый, черный	385/485/640/940 1250/1542
СAB 4	T8	10/15/18 30/36/58	белый	380/485/640 945/1240/1550
СAB 5	2*T8	2*18/2*30/2*36	белый	640/945/1250
TL 3013S	T8	10/15/18 30/36/58	белый	380/485/640 945/1240/1550
TL 3017S	2*T8	2*18/2*30/2*36	белый	640/945/1250
СAB 35	T8	10/15/18/30/36	белый	500/600/750/1006/1364
СAB 35	G23	11	белый	410
СAB 1A/ СAB 2A	T4	8/16/20	серебро	373/499/598
СAB 89A	T5	8/13/21	серебро, золото	755/935/1275
СAB 89B	T5	8/13	серебро, золото	705/935
СAB 90	T5	8/13	серебро	570/720
СAB 34	T5	13/21	серебро	560/860
TL 2016	T5	8/13	серебро	350/378
TL 2018B	T5	8/13	серебро	580/889
TL 2018C	T5	21/28	серебро	1225/1525
СAB 45	T5	8/13/21	серебро	375/650/935
СAB 46 с розеткой	T5	8/13/21	серебро	450/680/1005
TL 2012	T4	8/12	золото, титан, серебро	340/560

DL 2

1751

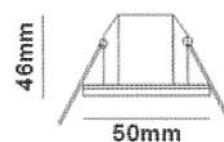
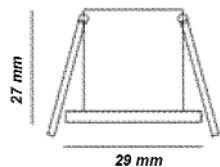

XM 2708A

2754

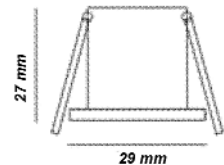
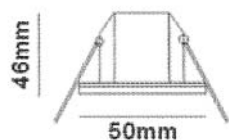

BS 3107/3107A/3107B/3107C

DL 1112

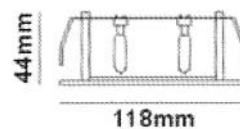
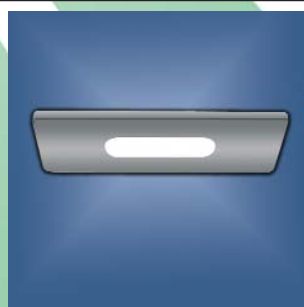
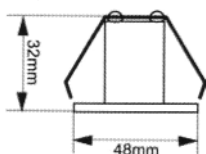
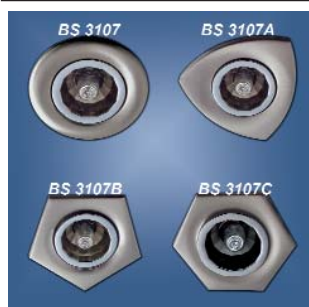

Наименование	Патрон	Лампа	Мощность, W	Цвет исполнения	Встраиваемый размер, мм
DL 2	G4	JC	20	белый/хром/золото/титан	D 26
1751	G4	JC	20	белый/хром/золото/титан	D 44
XM 2708A	G4	JC	20	белый/розовый/ зеленый/синий	D 44
BS 3107	G4	JC	20	титан	D 44
BS 3107A	G4	JC	20	титан	D 44
BS 3107B	G4	JC	20	титан	D 44
BS 3107C	G4	JC	20	титан	D 44
DL 1112	G5.3	2*JC	2*20	белый/хром/золото/титан	110x15

A 012 / A012N

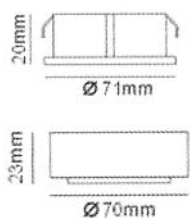

BS 820 / BS 821

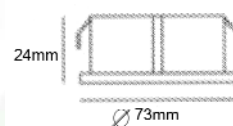

A 014

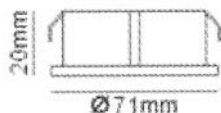

DL 3



DL 3A

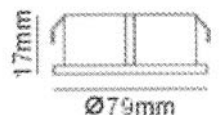

DL 4



Наименование	Патрон	Лампа	Мощность, W	Цвет исполнения	Встраиваемый размер, мм
A 012	G4	JC	20	белый/хром/золото/титан	D 54
A 012N	G4	JC	20	белый/хром/золото/титан	D 54
BS 820	G4	JC	20	хром/золото/титан	60
BS 821	G4	JC	20	хром/золото/титан	60
A 014	G4	JC	20	белый/хром/золото/титан	D 54
DL 3	G4	JC	20	белый/хром/золото/титан	D 54
DL 3A	G4	JC	20	белый/хром/золото/титан	D 60
DL 4	G4	JC	20	белый/хром/золото/титан	D 54



BS 101C

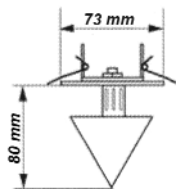
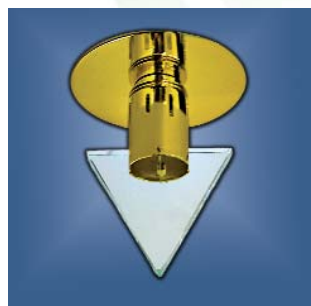

BS 112C

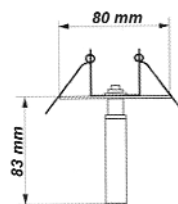

BS 125FB

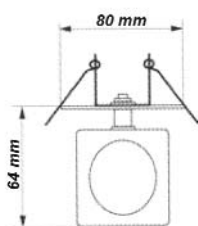

BS 125FA

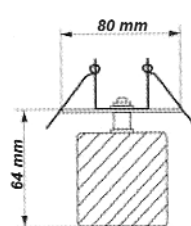

BS 114C

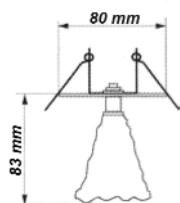

41901

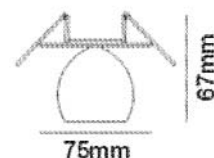

1531

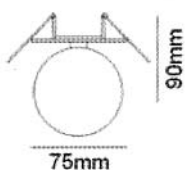

1782

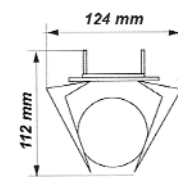

BS 92C

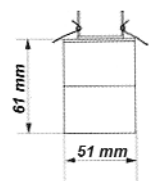

BS 92R

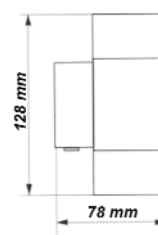
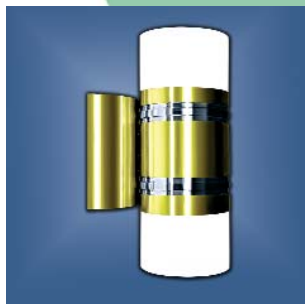

BS 24C

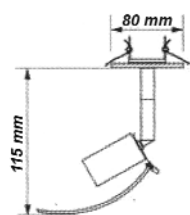

BS 25C

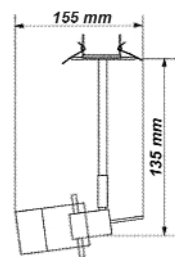

BS 25R

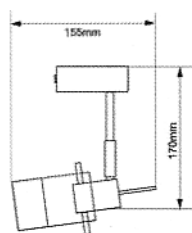

XM 2707

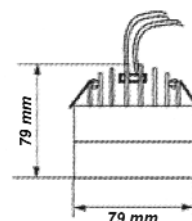

DL-121

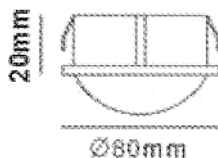

36N GLS

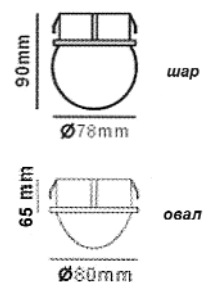

730W / 730CW

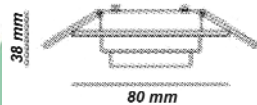

BS 3159-P2-8 / 9 / 10 / 12

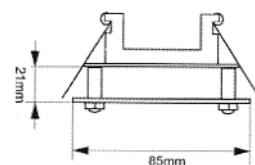

2782

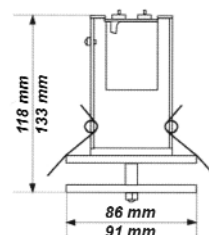
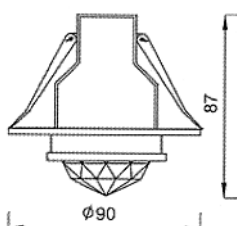

4720

3781

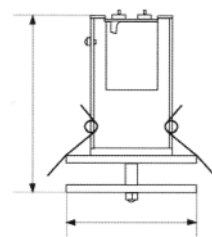
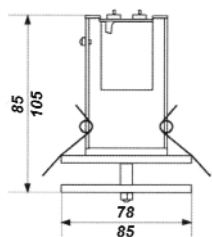

156-R39/156-R50

301

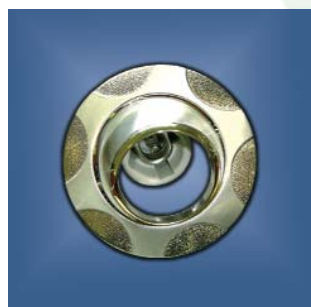

305

098S

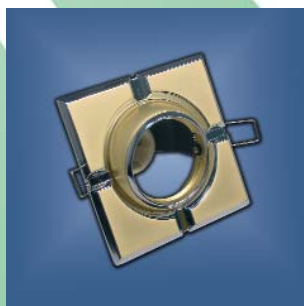

020 рефлекторный

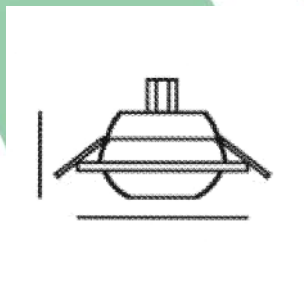
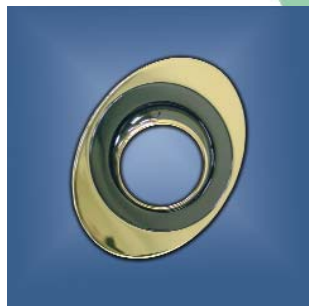
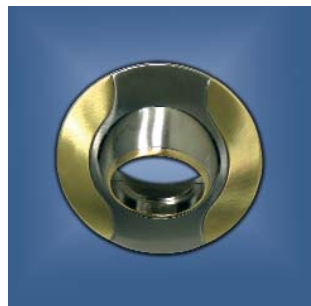

DLT 023E



305 T



DLT 024E



DLT 046



DLT 064

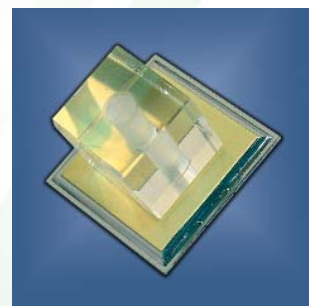

DLT 065



020T

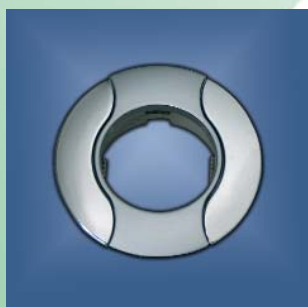

098T/098TS



108T



Наименование	Патрон	Лампа	Мощность, W	Цвет исполнения	Встраиваемый размер, мм
BS 101C	G4	JC	20	хром/золото/титан	D 40
BS 112C	G4	JC	20	хром/золото/титан	D 40
BS 125FB	G4	JC	20	хром/титан	D 40
BS 125FA	G4	JC	20	хром/титан	D 40
BS 114C	G4	JC	20	хром/золото/титан белый/розовый/синий	D 40
41901	G4	JC	35	хром/золото/титан/белый	D 40
1531	G5.3	JC	20	хром/золото бел/желт/красн/зелен/син	D 40
1782	G5.3	MR16	50	хром/золото бел/розов/зелен/син	D 50
BS 92C	G5.3	JC	20	мат.золото/мат.хром	D 40
BS 92R	G5.3	JC	2*20	мат.золото/мат.хром	-
BS 24C	G5.3	MR16	50	хром/золото/титан	D 50
BS 25C	G5.3	MR16	50	хром/золото/титан	D 50
BS 25R	G5.3	MR16	50	хром/золото/титан	
XM 2707	G5.3	JC	35	хром/золото белый/синий/розовый	D 60
DL 121	G4	JC	20	белый/хром/золото/титан прозрачный/матовый	D 64
36N GLS шар	G4	JC	20	хром/золото	D 64
36N GLS овал	G4	JC	20	хром/золото	D 64
730W/730CW	G5.3	MR16	50	хром/золото бел/розов/зелен/сини	D 45

Наименование	Патрон	Лампа	Мощность, W	Цвет исполнения	Размер, мм
BS 3159-P2 8	G5.3	MR16	50	хром/золото/титан	встр. 71x71
BS 3159-P2 9	G5.3	MR16	50	хром/золото/титан	встр. 71x71
BS 3159-P2 10	G5.3	MR16	50	хром/золото/титан	встр. 71x71
BS 3159-P2 12	G5.3	MR16	50	хром/золото/титан	встр. 71x71
2782	G5.3	MR16	50	хром/золото	встр. D 71
1787/1788	E14/E27	R50/R63	40/60	белый/хром/золото	встр. D 66/71
4720	E14/E27	R50/R63	40/60	золото/хро/маговое золото	встр. D 58/65
3781	E14/E27	R50/R63	40/60	бел/сереб/хром/золото	встр. D 58/65
156 R-39/156 R-50	E14	R39/R50	40/60	мат.золото-хром, маговой хром	62x85/80x100
125 R-39/125 R-50	E14	R39/R50	40/60	золото-золото, титан-серебро серебро-золото хром-серебро мат.хром-хром	62x85/80x100
301	G4/G5.3	MR11/MR16	35/50	5 цветов	67x27/100x27
301 рефлекторный	E14	R39/R50	40/60	5 цветов	66x80/82x100
301T	G4/G5.3	MR11/MR16	35/50	5 цветов	67x27/83x27
305	G4/G5.3	MR11/MR16	35/50	5 цветов	83x27/100x27
305 рефлекторный	E14	R39/R50	40/60	5 цветов	66x80/82x100
305T	G4/G5.3	MR11/MR16	35/50	5 цветов	83x27/80x27
098	E14	R39/R50	40/60	5 цветов	85x65/100x75
098S	E14	R39/R50	40/60	5 цветов	80x80x65/100x100x75
098T	G4/G5.3	MR11/MR16	35/50	5 цветов	70x20/85x20
098TS	G4/G5.3	MR11/MR16	35/50	5 цветов	70x70x20/85x85x20
020	E14	R39/R50	40/60	5 цветов	85x65/100x75
020T	G4/G5.3	MR11/MR16	35/50	5 цветов	65x25/80x25
DLT 023E	G5.3	MR16	50	жемчуж.хром-хром маговое золото-хром	82x20
DLT 034	G4	MR11	35	мат.золото-хром, мат.серебро-хром титан-хром	63x63x20
DLT 035	G5.3	MR16	50	мат.золото-хром, мат.серебро-хром титан-хром	80x80x20
DLT 061	G4	MR11	35	мат.золото-хром мат.серебро-хром титан-хром	65x65x20
DLT 062	G5.3	MR16	50	мат.золото-хром мат.серебро-хром титан-хром	82x82x20
DLT 024E	G5.3	MR16	50	жемчуж.хром-хром маговое золото-хром	80x80x20
DLT 046	G4	MR11	35	жемчуж.хром-хром маговое золото-хром	60x60x20
DLT 064	G4	JC	20	жемчуж.хром-хром маговое золото-хром	65x65x20
DLT 065	G4	MR11	35	жемчуж.хром-хром мат.золото-хром	65x15
108	E14	R39/R50	40/60	5 цветов	80x105x70/90x120x85
108T	G4/G5.3	MR11/MR16	35/50	5 цветов	60x80x20/80x105x20

DL 6301

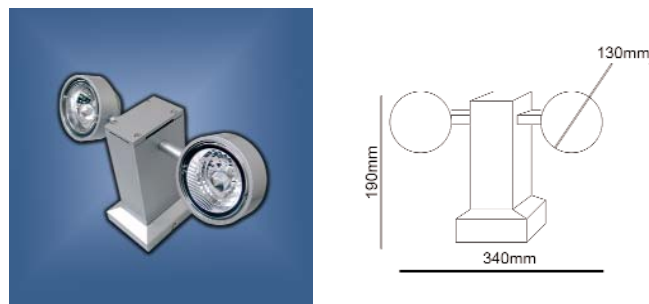

DL 6302

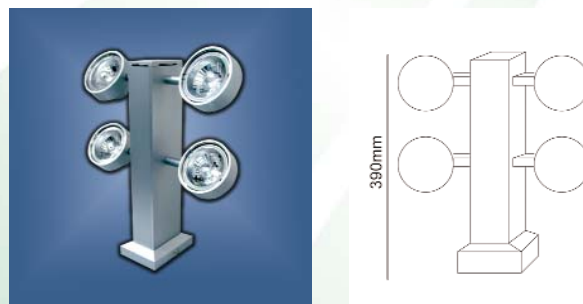

DL 6303

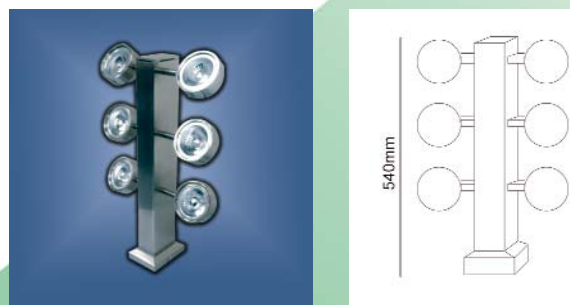

DL 7105

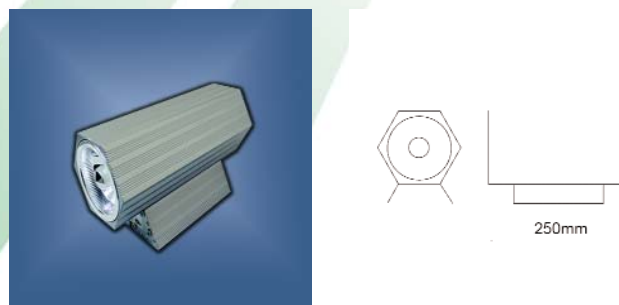

DL 7102

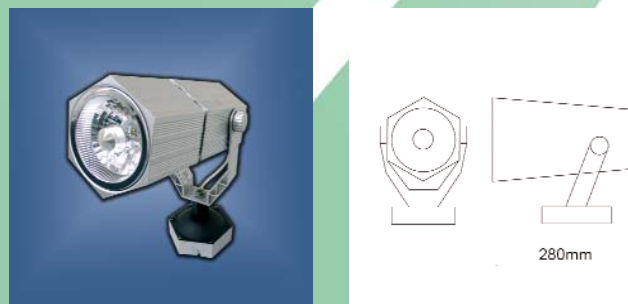

DL 7103

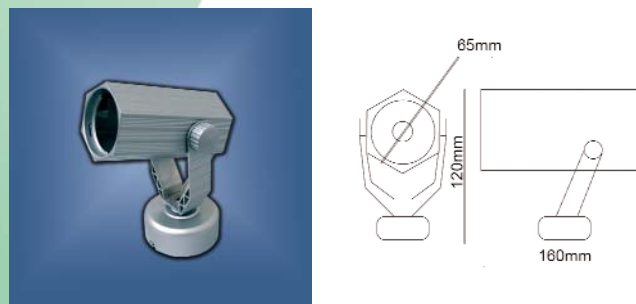

DL 7104

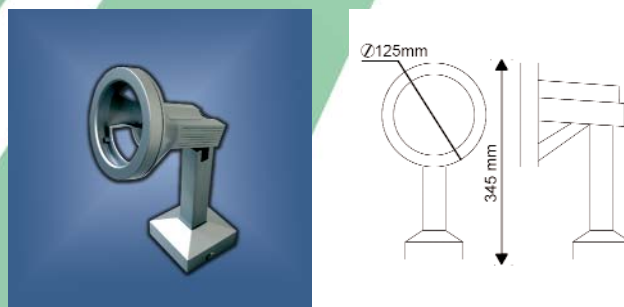

Наименование	Патрон	Лампа	Мощность, W	Цвет исполнения	Размер, мм
DL 6301	QR70	JC	2x50	серый, титан	190x130x340
DL 6302	QR70	JC	4x50	серый, титан	390x130x340
DL 6303	QR70	JC	6x50	серый, титан	540x130x340
DL 7105	QR70	JC	2x50	серый	250x130
DL 7102	QR70	JC	50	серый	225xD105x280
DL 7103	E14	R50	40	серый	120xD65x160
DL 7104	E27	PAR30	100	серый	345xD125

855

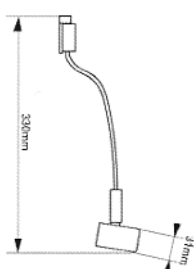

849

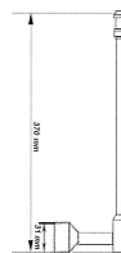

1471-4

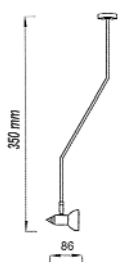

1471-5



451J

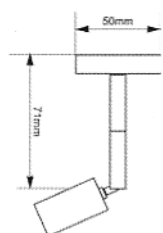

427J

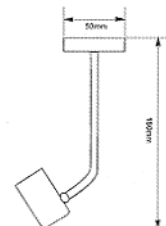
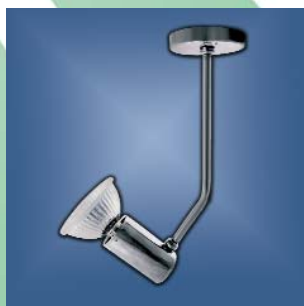

DL 131

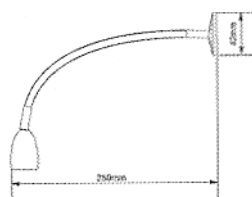

895-1



1471-6

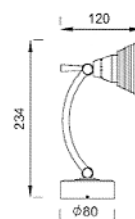
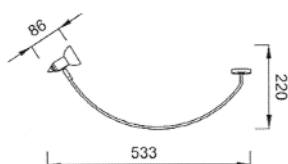
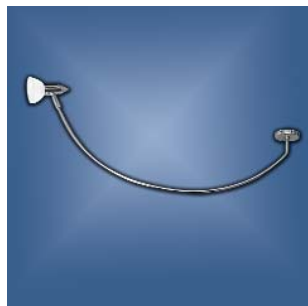

SI 211

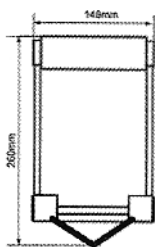
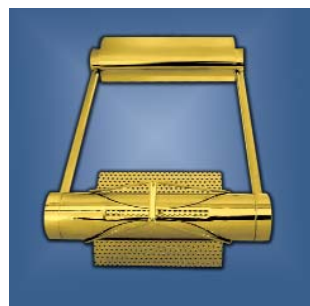

TR 1302

TR 1303

1436



TR 1301



TR1304

TR1305



RAD 50S/63S

RAD 50-2/63-2 и RAD 50-3/63-3

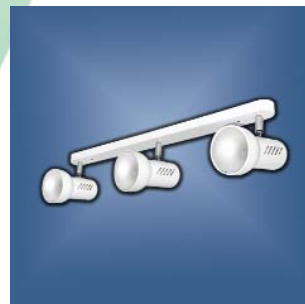

Наименование	Патрон	Лампа	Мощность, W	Цвет исполнения	Размер, мм
855	G5.3	MR16	50	хром, золото	330x31
849	G5.3	MR16	50	хром, золото	370x31
1471-4	G5.3	JC	35	хром	350x86
1471-5	G5.3	JC	35	хром	138x576
1471-6	G5.3	JC	35	хром	220x533
451J	G5.3	MR16	50	хром, золото	71x50
427J	G5.3	MR16	50	хром, золото	100x50
DL 131	G5.3	MR16	50	хром, золото, титан	250x42
864	G5.3	MR16	50	хром, золото	230x65
895-1	G5.3	MR16	50	серебро, хром, мат.хром	120x234
SI 211	R7s	J78	100	хром, золото	148x260
1436	G5.3	MR16	50	хром, золото	60x60x35
TR 1301	GU10	MRG/MR16	50	матовое золото, титан	Дос 80, Ллп 80 дплаф 55
TR 1302	GU10	MRG/MR16	2*50	матовое золото, титан	Лдуги 400, Ллп 80 дплаф 55
TR 1303	GU10	MRG/MR16	3*50	матовое золото, титан	Лдуги 700, Ллп 80 Досн 80, дпла 55
TR 1304	GU10	MRG/MR16	4*50	матовое золото, титан	Лдуги 920, Ллп 80 Досн 80, дплаф 55
TR 1305	GU10	MRG/MR16	4*50	матовое золото, титан	Лдуги 400, Ллп 80 Досн 80, дпла 55
RAD 50S/63S	E14/E27	R50/R63	40/60	белый, хром, золото, титан	Лосн 85, Ллп 120/150
RAD 50-2/63-2	E14/E27	R50/R63	2*40/2*60	белый, хром, золото, титан	Лосн 360, Ллп 120/150
RAD 50-3/63-3	E14/E27	R50/R63	3*40/3*60	белый, хром, золото, титан	Лос 360/420, Ллп 120/150
RAD 50-2R/50-3R	E14	R50	2*40	белый, хром, золото, титан	Дос 240, Ллп 120



A2 C333 2"/A3 C333 3" и A 2"/2,5"/3"/3,5"/4"/5"/6" C111

1713/1714/1715/2746



2767

3758

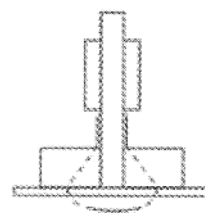

DL 48/ DL 49

3729

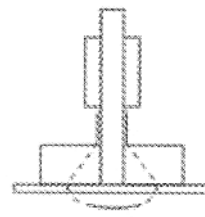
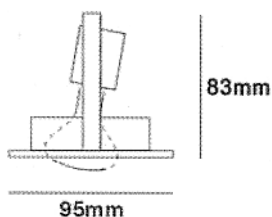

DM 1/2/2,5 701

2712

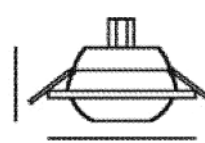
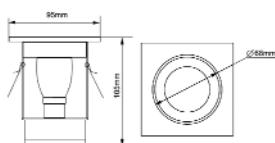

DL 5501

DL 5502

DL 5503/DL 5504

AL 8011



Наименование	Патрон	Лампа	Мощность, W	Цвет исполнения	Встраиваемый размер, мм	Размеры, мм
A2 C333 2"	E14	R50	60	бел/хром/зол/титан	70	100x120
A3 C333 3"	E27	R63	75	бел/хром/зол/титан	95	125x130
3729	E14/E27	R39/R50/R63	40/60/75	сереб/хром/зол	D44/65/80	68x82/85x96/100x116
1713	E14	R50	60	12 цветов *	D65	85x92
1714	E27	R63	60	9 цветов **	D80	110x115
1715	E27	R80	100	бел/хром/зол/титан	D115	125x125
2746	E14	R39	40	12 цветов *	D44	64x82
2767	E14	R39/R50/R63	40/60/60	6 цветов ****	D44/65/75	67x82/85x96/95x116
3758	E14/E27	R39/R50/R63	40/60/60	бел/зол/хром/сереб	D44/58/63	67x82/78x96/88x116
4719	E14/E27	R39/R50/R63	40/60/60	мат.зол/зол/хром/титан	D44/55/65	65x70/75x80/85x100
DM 1701 DM 2701 DM 2S701	E14/E27	общего назначения	40/60	белый/хром/титан	D 64 D 74 D 85	84x104 94x103 105x125
A C111 2"/2,5"/3" 3,5"/4"/5"/6"	E14/E27	R39/R50/R63/R80	40/60/75/100	белый/хром/золото	2" 75 2,5" 75 3" 95 3,5" 100 4" 120 5" 155 6" 170	2" 95x115 2,5" 95x115 3" 115x120 3,5" 120x120 4" 140x180 5" 175x180 6" 190x200
2712	E14/E27	R39/R50/R63	40/60/75/100	8 цветов***	D60/84/112	80x70/104x85/132x100
AL 8011	E14/E27	R39/R50/R63/R80	40/60/80	белый/хром	2,5" 90 3" 100 4" 125 6" 175	2,5" 110x150 3" 120x150 4" 140x170 6" 190x200
DL 48AM DL 48 M DL 49M	E14 E14 E27	R39 R50 R63	40 60 60	белый/золото/хром титан	D57 D74 D92	82x77 100x94 115x112
DL 5501 DL 5502 DL 5503 DL 5504	E14	R39	1*40 2*40 3*40 4*40	белый	80x80 145x80 225x80 300x80	90x115x90 165x115x90 240x115x90 315x115x90

BS 3121

41971/41972/41973

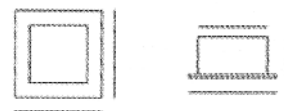
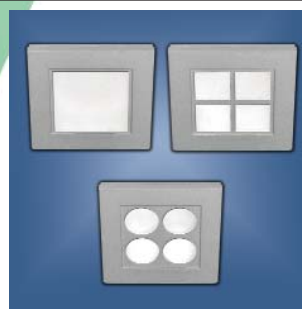
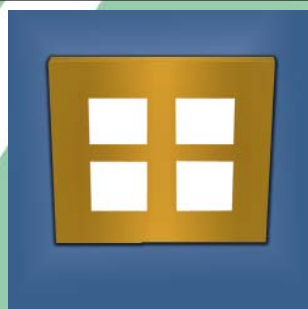

41949

2769/2770

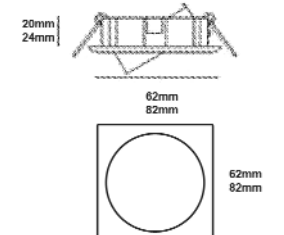
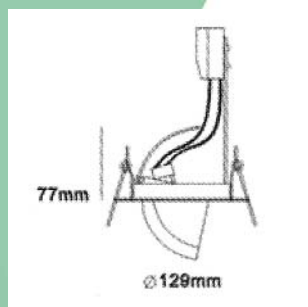

1765/1759

DL 132

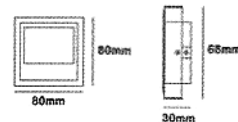
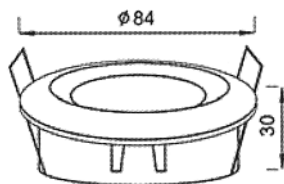

DL 133

DL 134

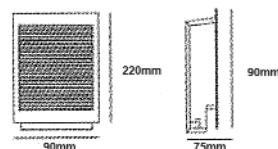
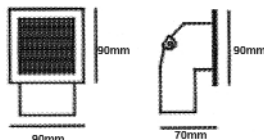

DL 7/DL 10

DL 135

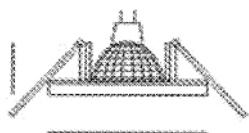

DL 8/DL 11

DL 9/DL 12

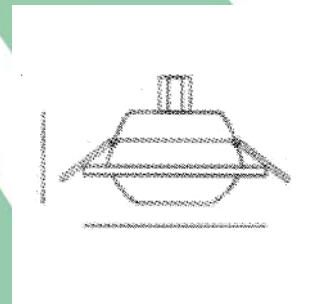
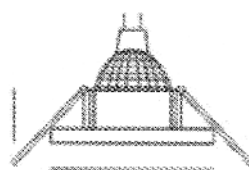

110A/DL 307

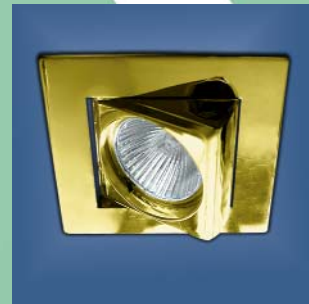
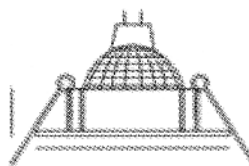

BS 3242D

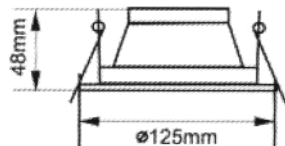

BS 3245

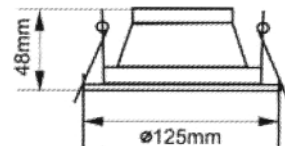

Наименование	Патрон	Лампа	Мощность, W	Цвет исполнения	Размер, мм
BS 3242D	G5.3	MR16	50	белый/хром/титан	48x125 встр.105
BS 3245	G5.3	MR16	50	белый/хром/титан	48x125 встр.105
3795	G5.3	MR16	50	бел/зол/титан/сереб/хром	100x25 встр. D80
41949	G5.3	MR16	50	белый/хром/титан/золото	129x77 встр.D105
110A/DL 307	G4/G5.3	MR11/MR16	35/50	белый/хром/титан/золото	60x23/77x25 встр.D50/58
110/DL 308	G4/G5.3	MR11/MR16	35/50	белый/хром/титан/золото	60x21/82x21 встр.D50/72
DL 7/DL 10	G4/G5.3	MR11/MR16	35/50	бел/хром/титан/зол/сереб	64x24/80x25 встр.D42/60
DL 8/DL 11	G4/G5.3	MR11/MR16	35/50	бел/хром/титан/зол/сереб	77x24/88x29 встр.D57/68
DL 9/DL 12	G4/G5.3	MR11/MR16	35/50	белый/хром/титан/золото	76x36/97x46 встр.D55/78
DL 13	G5.3	MR16	50	белый/хром/титан/золото	80x25 встр.D60
2769/2770	G4/G5.3	MR11/MR16	35/50	бел/хром/титан/зол/сереб	62x20/82x24 встр.D55/75
1765/1759	G4/G5.3	MR11/MR16	35/50	хром/золото	64x20/84x30 встр.D55/75
DL 132	G4	JC	20	матированный хром	80x80 68x30 встр.68x68
DL 133	G4	JC	20	матированный хром	90x90 90x70 встр.80x80
DL 134	R7s	J78	100	матированный хром	200x90x75
41971	G5.3	MR16	20	серый	90x90 72x60x90 встр.80x80
41972	G5.3	MR16	20	серый	90x90 72x60x90 встр.80x80
41973	G5.3	MR16	20	серый	90x90 72x60x90 встр.80x80
DL 135	G5.3	JC	50	матированный хром	90x110 встр.70
BS 3121	G5.3	MR16	50	белый/хром/титан/золото	87x87 60x65
BS 3122	G5.3	MR16	50	белый/хром/титан/золото	87x87 60x65

*LED G01*



*LED-ID01A*

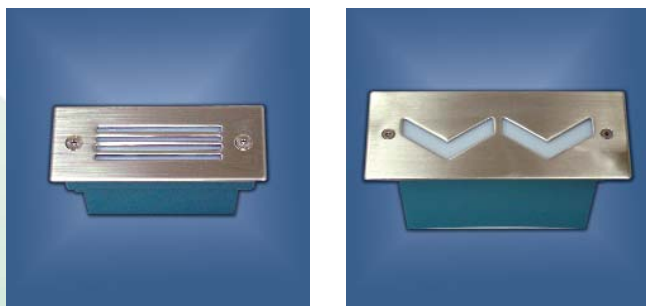

*LED-ID03-B*

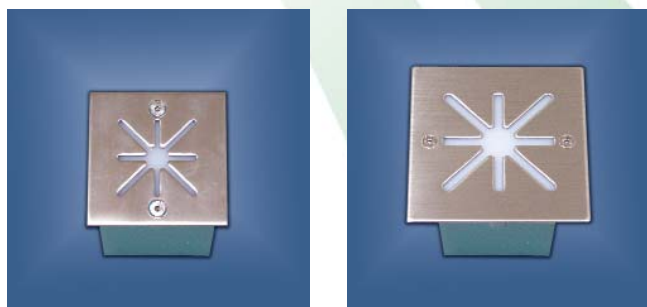

*LED-ID21/ID20*



*LED-ID32*



*LED-OD36*



*LED-OD58/54/55*

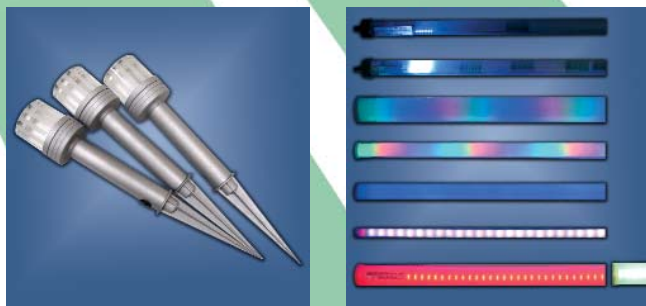

$$1LED = 0.0774W$$

Наименование	Кол-во LED	Напряжение, V	Цвет свечения	Размер, мм
LED-GO1	16LED	220	белый	150x150x125
LED-GO2	20LED	220	белый	170x170x125
LED-ID01-A/E	12LED	220	белый, зеленый, красный, синий	45x110x55
LED-ID01-B/C/D/F	12LED	220	белый	45x110x55
LED-ID02-A/E	16LED	220	белый, зеленый, красный, синий	170x70x90
LED-ID02-B/C/D/F	16LED	220	белый	170x70x90
LED-ID02-F/G/H	16LED	220	белый	170x70x90
LED-ID03-A "квадрат"	9LED	220	белый, зеленый, красный, синий	70x70x55
LED-ID03-B "квадрат"/C/E	9LED	220	белый	70x70x55
LED-ID03-D "квадрат"	9LED	220	белый, зеленый, красный, синий	70x70x55
LED-ID04-A "квадрат"/B/C/D/E	16LED	220	белый	150x150x95
LED-ID04-F "квадрат"	16LED	220	белый	150x150x95
LED-ID20	14LED	220	белый, зеленый, красный, синий	120x120x65
LED-ID21	14LED	220	белый, зеленый, красный, синий	D120 H65
LED-ID30	14LED	220	белый, зеленый, красный, синий	D100 H110
LED-ID31	25LED	220	белый	D125 H110
LED-ID32	40LED	220	белый	D150 H110
LED-ID33/34	25LED/36LED	220	белый	140x140/240x120
LED-OD04	3*12LED	220	белый, зеленый, красный, синий	D65 H400
LED-OD36	18LED	220	белый	D190 H70
LED-OD37	36LED	12	белый	D115 H20
LED-OD54	24LED	220	белый, зеленый, красный, синий	150x100x65
LED-OD55/56	36LED	220	белый, зеленый, красный, синий	200x100x65/200x200x65
LED-OD58	3LED	220	белый, зеленый, красный, синий	80x50x65
LED-OD59	9LED	220	белый, зеленый, красный, синий	80x80x65
LED-OD60	16LED	220	белый, зеленый, красный, синий	100x100x65
LED-OD61	25LED	220	белый, зеленый, красный, синий	150x150x65
LED-PO1	1*12LED	220	белый, зеленый, красный, синий	D65 H400
LED-DT1-60-11	144	220	мультицвет	D60 L1000
LED-SL-4B/8B (4 стробы/8 строб)	4*60/8*60	220	белый	D55 L1555
LED-TT1-26-90	90	220	7 цветов	D26 L1000
LED-TT1-50-108	108	220	3 цвета/7 цветов	D50 L1000
LED-TT1-50-108	108	12	3 цвета	D50 L1000
LED-TT1-50-144	144	12/220	3 цвета	D50 L1000
LED-TT1-50-90	90	220	7 цветов	D50 L1000
LED-TT1-80-108	108	220	3 цвета	D80 L1000

### НАСТОЛЬНЫЕ

Наименование	Патрон	Лампа	Мощность, W	Цвет исполнения
DE1001	E27	ESB	20	белый/синий/черный/серебро
DE1006	E27	ESB	20	белый/черный
DE1007	E27	ESB	20	белый/синий/черный/серебро
DE1008	E27	ESB	20	белый/синий/черный/серебро
DE1009	E27	ESB	20	белый/синий/черный/серебро
DE1010	E27	ESB	20	белый/синий/черный/серебро
DE1103	G23	ESB	11	серебро
DE1204	G23	ESB	11	белый/черный/серый
DE1205	G23	ESB	11	белый/черный/серый
DE1402	G23	ESB	11	зеленый-желтый/сине-красный
DE2006	GU10	MGR	50	серебро/черный
DE2108	G5.3	JC	35	хром-синий/хром-черный
DE2206	G4	JC	20	бел/зол/красн/син/черн/серебро
DE3101	E27	накаливания	60	белый/красный/синий/черный
DE3112	E27	накаливания	60	белый/серебро/фиолет/черный
DE3201	E27	накаливания	60	белый/красный/синий/черный

DE 3101



DE 3201



DE 1103



DE 1006

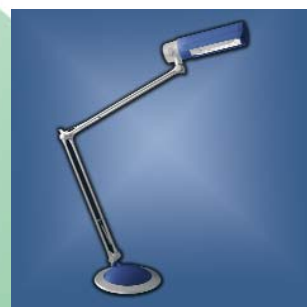

DE 1008



DE 1010

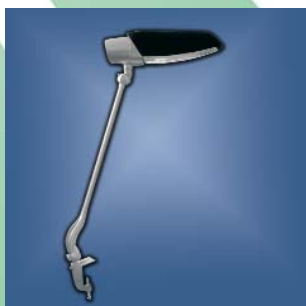

DE 1205



DE 2006

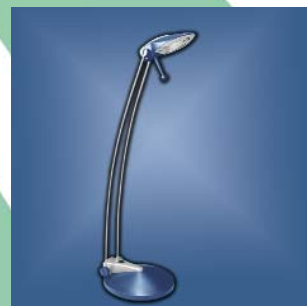

## прожекторы

FL1/2/4/4S/5

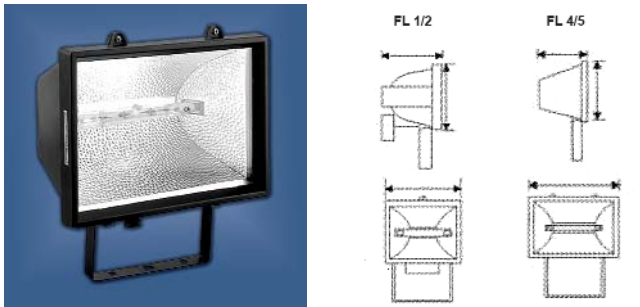

FL 23/24



FL 32/33

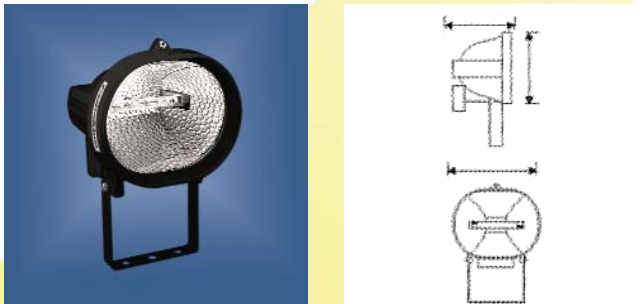

GL 2307/2308



GL 2303

616

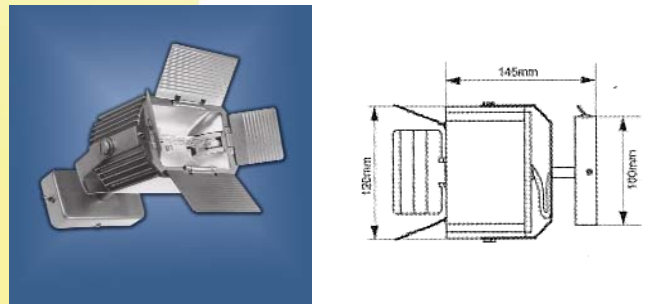
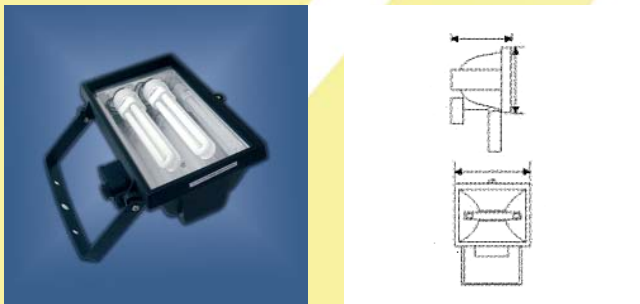

GL 2602/2702

FL 12N

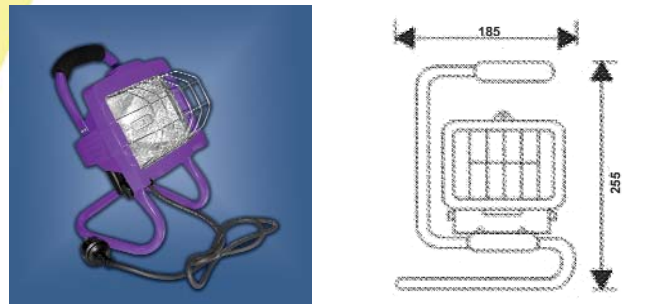
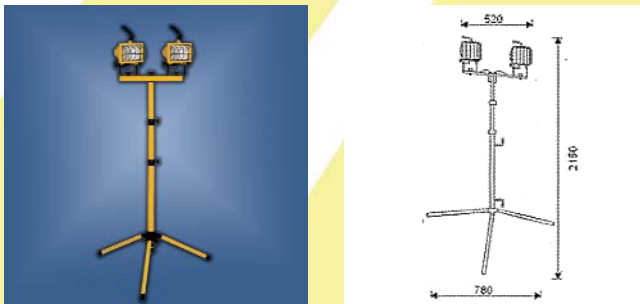

GL 2410





SP 010

SP 026

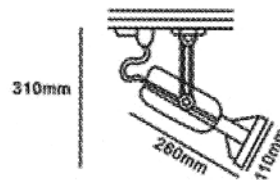
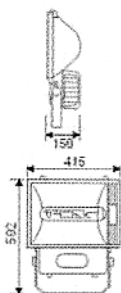

SP 03

SP 011

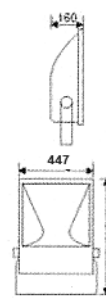
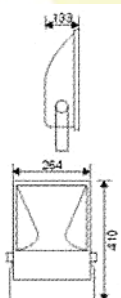

SP 07

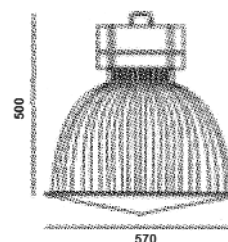
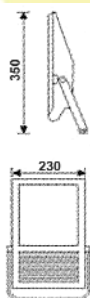

Наименование	Патрон	Лампа	Мощность, W	Цвет исполнения	Размер, мм
FL1	R7s	J78	150	белый/черный/фиолет	140x95x185
FL2	R7s	J118	500	белый/черный/фиолет	185x135x280
FL4	R7s	J189	1000	белый/черный	275x150x305
FL4S	R7s	J189	1000	белый/черный	255x118
FL5	R7s	J254	1500	белый/черный	340x175x410
FL 23/24	R7s	J78/J118	150/500	белый/черный	138x123x209/184x135x272,5
FL 32/33	R7s	J78/J118	150/500	белый/черный	140x95x185/185x135x280
GL 2307/2308	R7s	J78/J118	150/300	белый/черный	125x85x210/165x85x250
GL 2303	G24	ESB	2*26	белый/черный	250x130
616	R7s	J78	150	серый	145x120x100
GL 2602/2702	R7s	J78/J118	2*150/2*500	желтый	520x1400x680/520x2150x780
FL 12N	R7s	J78/J118	150/500	фиолетовый	185x255/190x295
SI 212	R7s	J118	150	серый	205x110
GL 2409	R7s	J118	500	белый/черный/серый	220x85
GL 2410	E27	ESB	2*18 + 1*24	черный	350x260
SP 010	E40	MHB	250/400	черный	415x150x502
SP 026	R7s	MHB	150	белый/серый	310x260x110
SP 03	R7s	MHB	70/150	черный	254x133x410
SP 011	E40	MHB	250/400	черный	447x160x483
SP 07	R7s	MHB	150	серый	350x230
SP 031	E40	MHB	400	прозрачный	500x570

# Прожекторы и фонари



## фонари

EL1



EL4



WL 1112



WL 10



TL 988B



## головные фонари

TL 9570A



TH 2214 3/5 LED



Наименование	Источник света	Мощность, W	Цвет исполнения	Размер, мм
EL1	лампа T5	2*8	белый	410x75x85
EL4	лампа T8	1*20	белый	680x90x100
WL112	-	1/1.5/3 млн.свечей	серый	210x180x120
WL10	-	1/1.5/3 млн.свечей	желтый	230x140x130
TL 988B	2G7	7	желтый, зеленый, синий	240x125
HT-7LED-004/003	7LED	0.54	стальной	-
TL 9570A	3LED	не более 0,5	черный	-
TL 9570C	8LED	0,6	черный	-
TH 2214 3/5LED	3LED/5LED	не более 0,5	синий	-

SP 1401

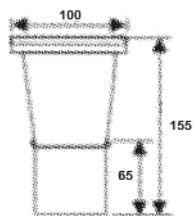

SP 1501

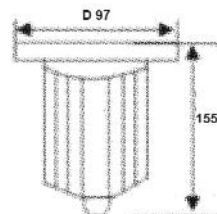

SP 1802

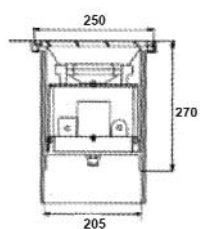

SP 1803

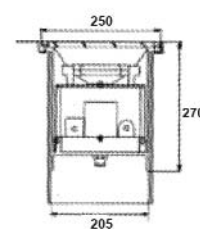

SP 2102

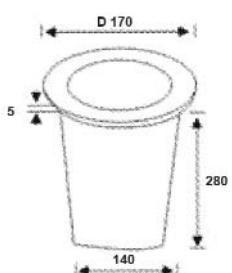

SP 1803

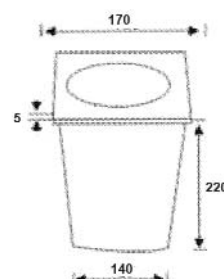

SP 2501

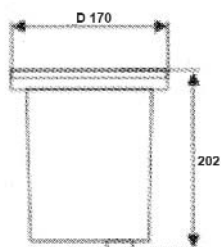

SP 2601

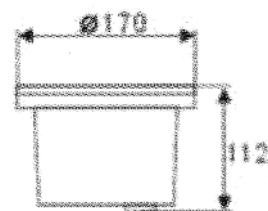

WL 4102

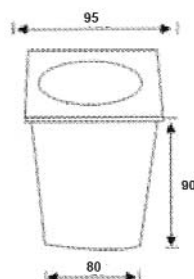

BSL-PO701F



BSL-PO201



BSL-PO525D-W

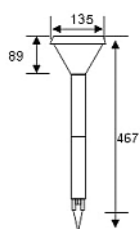

BSL-PO520L-W

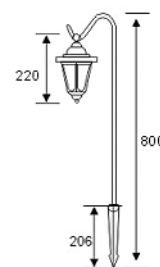

BSL-P0524D-W

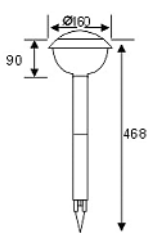

BSL-0508D-W

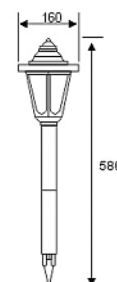
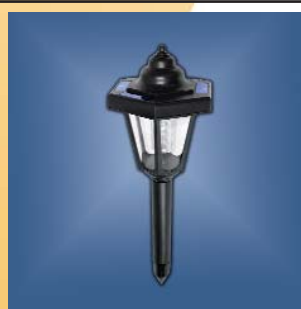

Наименование	Патрон	Лампа	Мощность, W	Цвет исполнения	Размер, мм
SP 1401	G5.3	MR16	50	черный	100x155x65
SP 1501	E27	PAR20	50	черный	155x97
SP 1802	R7s	MHB	150	черный	250x270x205
SP 1803	R7s	MHB	150	черный	250x270x205
SP 2102	G24	PL/ESB	18	зеленый	170x220x140
SP 2202	G24	PL/ESB	18	зеленый	170x220x140
SP2501	E27	PAR38	150	черный	170x202
SP 2601	E27	PAR38	100	черный	170x112
WL 4102		JCDR 18LED	1-2	металлик	95x90x80
BSL-PO701F	солнечная батарея	1 светодиод	1	бел./желт./зел./красн./син	
SL-P0524D-W	солнечная батарея	1 светодиод	1	черный	160x90x468
BSL-P0525D-W	солнечная батарея	1 светодиод	1	черный	135x89x467
BSL-PO201	солнечная батарея	1 светодиод	1	черный	
BSL-P0508D-W	солнечная батарея	1 светодиод	1	черный	160x580
BSL-S0401D-W	солнечная батарея	1 светодиод	1	нержавеющая сталь	
BSL-P0520L-W	солнечная батарея	1 светодиод	1	черный	220x206x800

GL 1101-01



GL 1102-01



GL 1103-01



GL 1104-01



GL 1105-01



Для всех светильников:  
 - материал - камень  
 - лампа MR16 12V 18 LED

### "пушкинские"

### IP 44

4101/4201

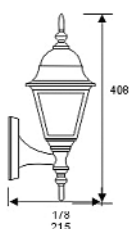

4102/4202

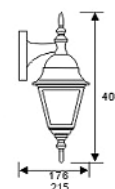
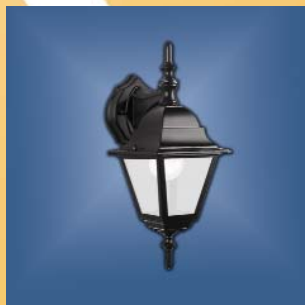

4104/4204

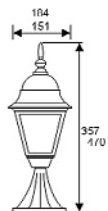

4105/4205



4103/4203/4210

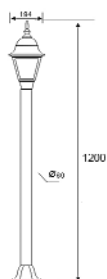

6101/6201

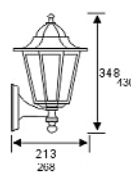

IP 44

6102/6202

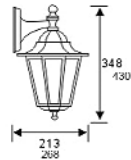

6104/6204

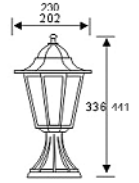

6105/6205

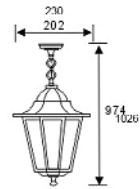

6103/6203/6210/6211

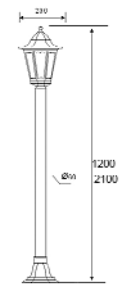

8001

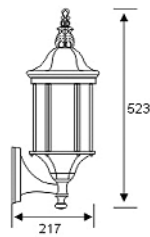

8004

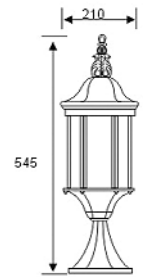

8005

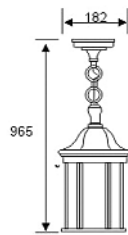

8003/8010

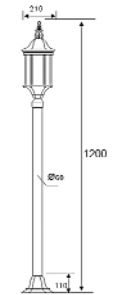

8101

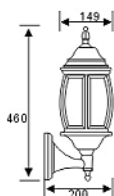

6215

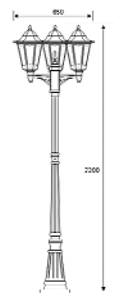

8105

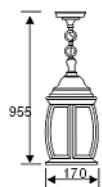

8103/8110/8111



8201

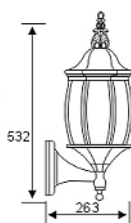

8204

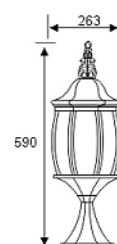

8205

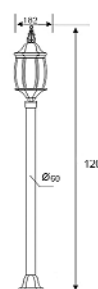

PL 8101/2/3/5 PL 8201/52/3/5

PL 5407

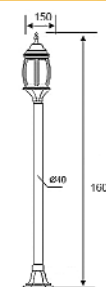
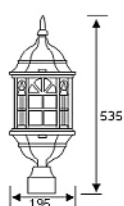

PL 5401/PL5501

PL 5504/PL 5404

PL 5601

PL 5508-3



PL 9501/PL 9601



PL 9504/PL 9604



PL9507



PL 9505/PL 9605



PL 9508-3



6206



Наименование	Патрон	Лампа	Мощность, W	Цвет исполнения/Размер, мм
4101/4201	E27	лампа накаливания	60/100	белый/черный
4102/4202	E27	лампа накаливания	60/100	белый/черный
4103/4203	E27	лампа накаливания	60/100	белый/черный
4104/4204	E27	лампа накаливания	60/100	белый/черный
4105/4205	E27	лампа накаливания	60/100	белый/черный
4210	E27	лампа накаливания	100	белый/черный
6101/6201	E27	лампа накаливания	60/100	бел/черн/пatina/чер.золото/чер.серебро
6102/6202	E27	лампа накаливания	60/100	бел/черн/пatina/чер.золото/чер.серебро
6103/6203	E27	лампа накаливания	60/100	бел/черн/пatina/чер.золото/чер.серебро
6104/6204	E27	лампа накаливания	60/100	бел/черн/пatina/чер.золото/чер.серебро
6105/6205	E27	лампа накаливания	60/100	бел/черн/пatina/чер.золото/чер.серебро
6206 с датчиком	E27	лампа накаливания	100	белый/черный
6210	E27	лампа накаливания	100	бел/черн/пatina/чер.золото/чер.серебро
6211	E27	лампа накаливания	100	белый/черный/черн.золото
6214/6215	E27	лампа накаливания	2*100/3*100	белый/черный/черн.золото
8001/2/3/4/5	E27	лампа накаливания	100	белый/черный
8010	E27	лампа накаливания	100	белый/черный
8101/2/3/4/5	E27	лампа накаливания	100	белый/черный/черн.серебро
8106/8206 с датчиком	E27	лампа накаливания	100	белый/черный
8110	E27	лампа накаливания	1*100	белый/черный/черн.серебро
8114/8115	E27	лампа накаливания	2*100/3*100	белый/черный
8201/3/4/5	E27	лампа накаливания	100	белый/черный
8210	E27	лампа накаливания	1*100	белый/черный
PL5401/5501	E27	лампа накаливания	100	черный D150/185, H520/560
PL5404/5504	E27	лампа накаливания	100	черный D150/185, H520/540
PL5407	E27	лампа накаливания	1*100	черный D150, H1600
PL5508-3	E27	лампа накаливания	3*100	черный D185, H2300
PL5601	E27	лампа накаливания	100	черный 760x400x260
PL8101/2/3/4/5	E27	лампа накаливания	60	пatina D135
PL8107	E27	лампа накаливания	1*100	пatina D135, H1200
PL8201/2/3/4/5	E27	лампа накаливания	100	пatina D170
PL9501/9601	E27	лампа накаливания	100/60	черный 210x450/175x400
PL9504/9604	E27	лампа накаливания	100/60	черный 210x530/175x430
PL9505/9605	E27	лампа накаливания	100/60	черный 210x400/175x330
PL9507	E27	лампа накаливания	1*60	черный D210, H1200
PL9508-3	E27	лампа накаливания	3*60	черный D175, H2200



DH 031A



DH 026BS/031B



DH 031C



DH 031D



DH 713

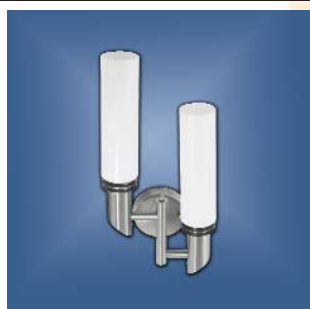

DH 714

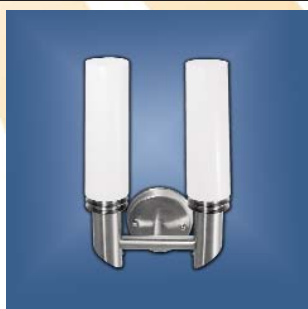

DH 026B

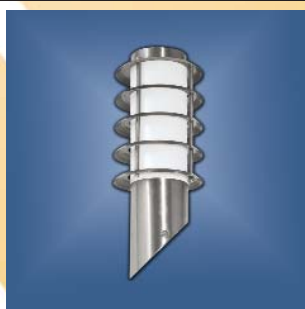

DH 026S/026

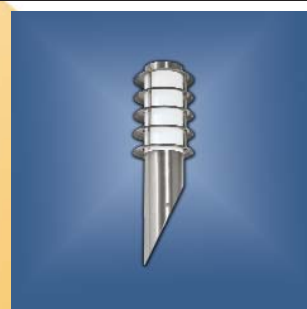

DH 026SA/026A



DH 026S-450/650/1100



DH 027-450/650/1100

DH 021B



DH 021S/021



DH 021A



DH 022WS-650/1100



DH 022S-450/650/1000



DH 022W-450/650/1100

DH 022-450/650/1100

DH 032S/032



DH 032WS-500/1000



DH 032W-500/1000

DH 032S-500/1000



DH 032-500/1000

DH 111B



## IP 44

DH 111A



DH 006



DH 001-1



DH 004-500



DH 004-1050



DH 111-600/1000



Наименование	Патрон/Лампа	Мощность, W	Материал	Размер, мм
DH 031A	E27/ESB	20	нержавеющая сталь	250x82x300
DH 026BS/031B	E27/ESB	20	нержавеющая сталь	250x82x300
DH 031C	E27/ESB	20	нержавеющая сталь	250x82x300
DH 031D	E27/ESB	20	нержавеющая сталь	250x82x300
DH 713	E27/ESB	2*20	нержавеющая сталь	245x130x475
DH 714	E27/ESB	2*20	нержавеющая сталь	245x130x380
DH 026B	E27/ESB	20	нержавеющая сталь	H 300
DH 026S/026	E27/ESB	20	нержавеющая сталь	H 400
DH 026SA/026A	E27/ESB	20	нержавеющая сталь	H 400
DH 026S-450/650/1100	E27/ESB	20	нержавеющая сталь	450/650/1100
DH 027-450/650/1100	E27/ESB	20	нержавеющая сталь	450/650/1100
DH 026WS-650/1100	E27/ESB	20	дерево/нержавеющая сталь	650/1100
DH 026W-450/600/1100	E27/ESB	20	дерево/нержавеющая сталь	450/650/1100
DH 021B	E27/ESB	20	нержавеющая сталь	H 300
DH 021S/021	E27/ESB	20	нержавеющая сталь	H 400
DH 021A	E27/ESB	20	нержавеющая сталь	H 380
DH 022WS-650/1100	E27/ESB	20	дерево/нержавеющая сталь	650/1100
DH 022W-450/650/1100	E27/ESB	20	дерево/нержавеющая сталь	450/650/1100
DH 022S-450/650/1100	E27/ESB	20	нержавеющая сталь	450/650/1100
DH 022-450/650/1100	E27/ESB	20	нержавеющая сталь	450/650/1100
DH 032S/032	E27/ESB	20	нержавеющая сталь	H 320
DH 032WS-500/1000	E27/ESB	20	дерево/нержавеющая сталь	500/1000
DH 032W-500/1000	E27/ESB	20	дерево/нержавеющая сталь	500/1000
DH 032S-500/1000	E27/ESB	20	нержавеющая сталь	500/1000
DH 032-500/1000	E27/ESB	20	нержавеющая сталь	500/1000
DH 111B	E27/ESB	20	нержавеющая сталь	H 400
DH 1111A	E27/ESB	20	нержавеющая сталь	H 400
DH 006	E27/ESB	20	нержавеющая сталь	231,5x190x247
DH 001-1	E27/ESB	20	нержавеющая сталь	231,5x190x349
DH 004-500	E27/ESB	20	нержавеющая сталь	H 530
DH 004-1050	E27/ESB	20	нержавеющая сталь	H 1050
DH 111-600/1000	E27/ESB	20	нержавеющая сталь	600/1000

**LX 01**

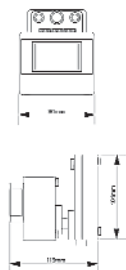

**LX 02**

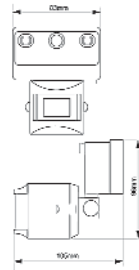

**LX 118B**

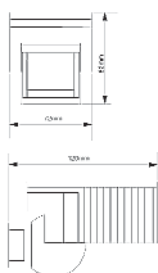

**LX 19**

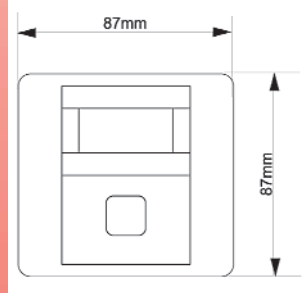

**LX 2000**

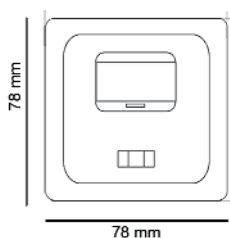

**LX 20**

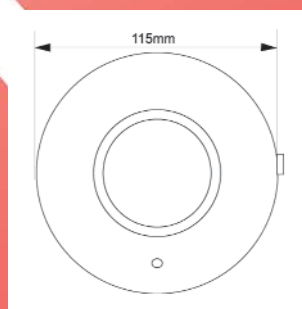

**LX 21**

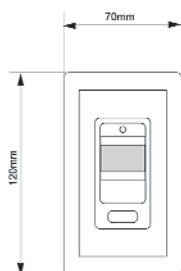

**LX 28A/B**

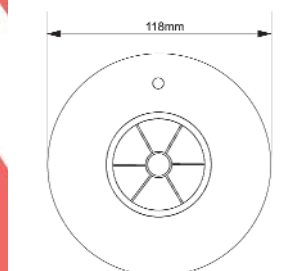

**LX 38**

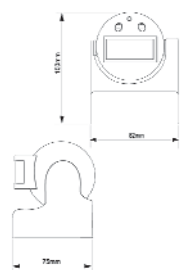

**LX 39**

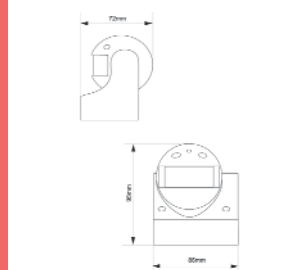
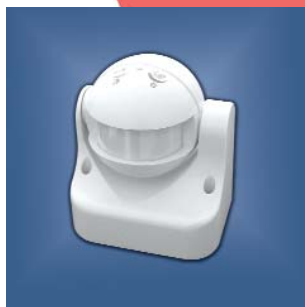

LX 48A

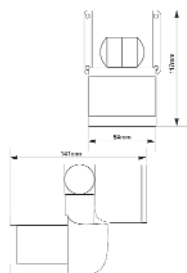

LXP 02/03

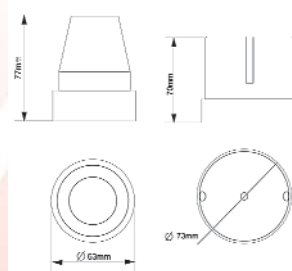

Наименование	Зона улавливания, градусы	Расстояние обнаружения, метры	Высота уствновки, метры	Мощность, W	Цвет исполнения
LX 01	120	12	2-4,5	1000	белый, черный
LX 02	120	12	2-4,5	500	белый, черный
LX 118B	180	12	0,5-3,5	1200	белый, черный
LX 19	120	9	1-1,6	600	белый
LX 2000	150	12	0,4-1,8	500	белый
LX 20	360	6	2-4	1200	белый
LX 21	180	9	1-1,6	1200	белый
LX 28A/B	360	12/20	1,5-3,5	1200	белый
LX 38	180	12	0,5-3,5	1200	белый, черный
LX 39	180	12	0,5-3,5	1200	белый, черный
LX 48A	220	12	1,5-2,5	1200	белый, черный
LX 02/03	фотоэлемент	освещенность 5-50LUX		сила тока 15A/20A	белый

## Розетки-таймеры

61923/61924



61921/61922



61925/61926



TM21



Наименование	Часы работы	Вид механизма	Цвет исполнения
61923	24	механическая	белый
61924 защищенный корпус	24	механическая	белый
61921	24	механическая	белый
61922 защищенный корпус	24	механическая	белый
61925	168	электронная	белый
61926 защищенный корпус	168	электронная	белый
TM 21	168	электронная	белый

TRA 110



TRA 1/2/3



TRA 12



TRA 15/16/17/18/23



TRA 19/22



TRA 25/26/27/28



TRA 51/53/54



TRA 205



TRA 120



TRA 203



PRO 12/13/14



PRO 11



Наименование	Вид	Материал	Коэффициент мощности	Мощность, W	Размеры, мм
TRA 110	электронный	пластмасса	0,9	50/60/105/150/ 200/250	75x32x22/95x44x26 125x52x28/130x63x40
TRA 1/2/3	электромагнитный	сталь		105/60/50	245x41x29/150x42x37
TRA 12	электромагнитный	сталь		300/500	92x93x128/140x55x72
TRA 15/16/17/18/23	электронный с защ. раб.темп: макс 65-85°	пластмасса	0,99	250/200/150/105/60	47x214x38
TRA 19/22	электронный раб.темп: макс 85°	пластмасса	0,95	105/80	18x175x52/19x168x42
TRA 25/26/27/28	электронный	алюминий	0,9	250/200/150/ 105/60/50	104x52x40/94x36x48 84x42x29/80x28x34
TRA 51/53/54	электронный с защ. раб.темп: макс 86°	пластмасса	0,97	50/60/105/150	73x20 (50/60W)/83x22 (105W) 116x40x75 (150W)
TRA 205	электронный, постоянного тока для светодиодных ламп раб.темп: макс 85°	пластмасса		6	72x20
TRA 120	электронный раб.темп: макс 80°	пластмасса	0,99	50/60	72x20
TRA 203	электронный раб.темп: макс 80°	пластмасса	0,99	300/400	145x65x40
PRO 12/13/14	таймер отключ. освещен. для санузл./лестничн.	пластмасса		150/300/500/1000	50x40x15/65x58x17
PRO 11	блок защиты	пластмасса		150/300/500/1000	55x30x12/80x50x12

**EB 16**



**LH 39/40/41**

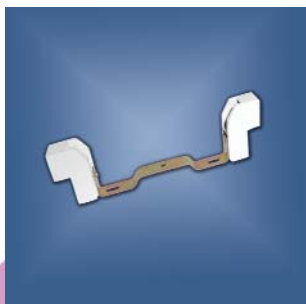

**EB 51S/EB52**



**LH 22/23/24/25**



**EB 54**



**LH 26**



**GB150**



**LH 32/34**



Наименование	Назначение	Мощность, W	Материал, характеристики
EB 16	для круглых люминесцентных ламп T9	22/33	пластмасса, E27 190/280x100
EB 51S/52	электронный	18/30/36W 2*18/2*30/2*36W	пластмасса, 190x32x25
EB 54	электронный	4*18/4*30/4*36W	сталь, 345x45x30
GB150	для металлогалогенных ламп	70/150W	пластмасса, 200x105x80

Патроны керамические, белого цвета;  
 LH 39/40/41 - R7s      LH 22/23/24/25 - G4  
 LH 26 - G5.3          LH 32/34 - GU10  
 LH29 - G9

## Удлинитель, детекторы

### удлинители многоместные

**KF 03**



**KFS-04**



**KF 04**



**KF 05/06**



### Детектор денег



### Детектор для ламп



Наименование	Кол-во гнезд	Длина шнура	Цвет исполнения/характеристики
KF 03	3	1,5/3/5	белый с (без) выключателем/с (без) заземлением
KF-S 04	4	1,5/3/5	белый с (без) заземлением
KF 04	4	1,5/3/5	белый с (без) выключателем/с (без) заземлением
KF 05/06	5/6	1,5/3/5	белый с (без) выключателем/с (без) заземлением
Детектор денег			черный 1LED, переключатель детектор /выкл./фонарик
Детектор для ламп			Цоколь: E10/E14/E27/G4/G5.3/G13/B15d, синий

## Дюралайт, ночники

### Дюралайт

### ST1

### Флэш-лампа

### NL 2/4/5/6



Наименование	Характеристики	Цвет свечения
ST1	стробоскоп, 220V	белый/красный/желтый/зеленый/синий
Флэш-лампа	цоколь- E27, 220V	желтый/зеленый/красный/прозрачный/синий
NL6/2/5	1 W - светильник ночной	белый, мультицвет

Наименование	Диаметр, мм	Кол-во ламп	Длина макс/мин, м
Дюралайт 2-х жильный, 6 цветов	13 мм, вертикальный	36 л/м, 1 лампа - 0,46 W	100/1
Дюралайт 3-х жильный, 6 цветов	13 мм, горизонтальный	72 л/м, 1 лампа - 0,46 W	100/1,5
Комплекты дюралайта 2,3,4 жил	13 мм		10
Дюралайт 2-х жильный, 5 цветов	13 мм	36LED/м, 1LED=0,077W	100/3
Дюралайт 3-х жильный, 5 цветов	11,5мм x 17,5мм	72LED/м, 1LED=0,077W	50/4-5

5 цветов: белый, желтый, зеленый, красный, синий

6 цветов: белый, желтый, зеленый, красный, синий, мультицвет

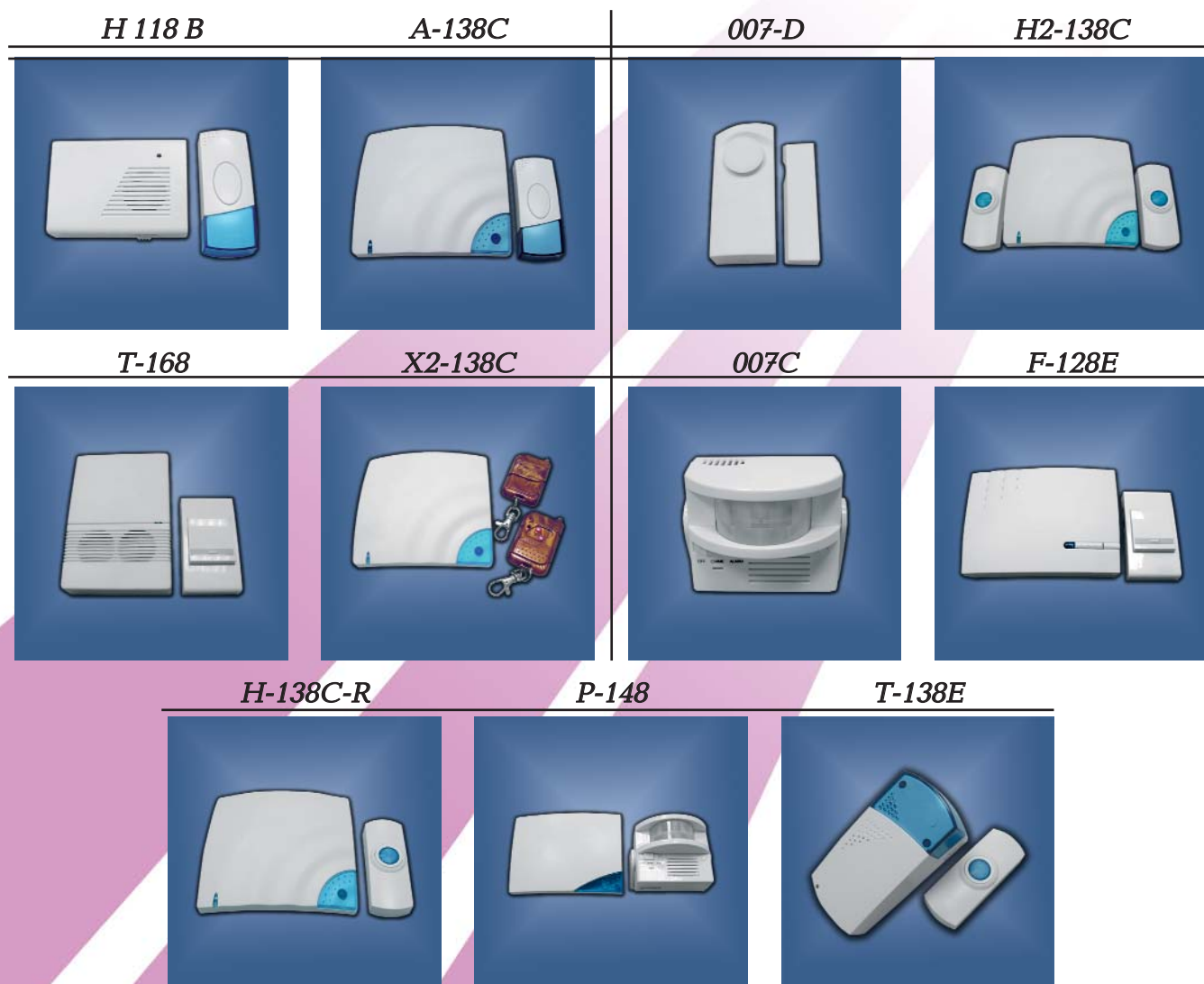

Наименование	Описание	Радиус действия	Характеристики
H 118B	беспроводной звонок	100м	2 мелодии питание: 2xAA 1.5V, 1x12V/23A
A-138C	беспроводной звонок	100м	32 мелодии питание: 3xAA, 1x12V/23A
007-D	дверной звонок/сигнализация	-	1 мелодия питание: 1xAA 1.5V
H2-138C	беспроводной звонок	100м	1 мелодия питание: 3xAA 1.5V, 2x12V/23A
T-168	беспроводной звонок	100м	1 мелодия питание: 3xAA 1.5V, 1x12V/23A
X2-138	беспроводной звонок	100м	2 мелодии питание: 3xAA 1.5V, 1x12V/23A
007C	инфракрасный датчик	H 1.5м	10 мелодий питание: 3xAA 1.5V
F-128E	беспроводной звонок	100м	32 мелодии питание: 3xAA 1.5V, 1x12V/23A
H-138C-R	беспроводной звонок	100м	1 мелодия питание: 3xAA 1.5V, 1x12V/23A
P-148	беспроводной звонок	100м H 1.5м	10 мелодий питание: 6xAA
T-138E	беспроводной звонок	100м	32 мелодии питание: звонок - от электросети 220V, передатчик - 1x12V/23A



# Карта цветов

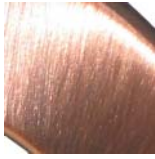

античная медь



белый



черное золото



дерево



матовый хром

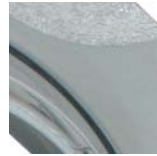

матовый хром-хром



матовый зеленый

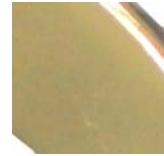

матовое золото



матовое золото-серый



розовый



серебро



серебро-золото



серый-хром



титан



титан-серебро



титан-хром



титан-золото



хром



хром-серебро



золото



золото-хром

